

OWNER'S MANUAL

MAGNAVOX
SMART. VERY SMART.

MC09D5MG

COLOR TV WITH BUILT-IN VCR



READ THIS MANUAL FIRST!

CONGRATULATIONS ON PURCHASING THIS PRODUCT. WE'VE INCLUDED EVERYTHING YOU NEED TO GET STARTED. IF YOU HAVE ANY PROBLEMS, OUR REPRESENTATIVES CAN HELP YOU GET THE MOST FROM YOUR NEW PRODUCT BY EXPLAINING:

- *HOOKUPS • FIRST TIME SETUP • FEATURE OPERATION*
- DO NOT ATTEMPT TO RETURN THIS PRODUCT TO THE STORE.*

FOR FAST HELP, CALL US FIRST!

1-800-705-2000

THANK YOU FOR MAKING US A PART OF YOUR HOME!



IMPORTANT!
*RETURN YOUR WARRANTY REGISTRATION CARD WITHIN 10 DAYS.
SEE WHY INSIDE.*

Return your Warranty Registration card today to ensure you receive all the benefits you're entitled to.

Once your MAGNAVOX purchase is registered, you're eligible to receive all the privileges of owning a MAGNAVOX product. So complete and return the Warranty Registration Card enclosed with your purchase at once. And take advantage of these important benefits.

Warranty Verification	Owner Confirmation	Model Registration
Registering your product within 10 days confirms your right to maximum protection under the terms and conditions of your MAGNAVOX warranty.	Your completed Warranty Registration Card serves as verification of ownership in the event of product theft or loss.	Returning your Warranty Registration Card right away guarantees you'll receive all the information and special offers which you qualify for as the owner of your model.

Congratulations on your purchase, and welcome to the "family!"



Dear MAGNAVOX product owner:

Thank you for your confidence in MAGNAVOX. You've selected one of the best-built, best-backed products available today. And we'll do everything in our power to keep you happy with your purchase for many years to come.

As a member of the MAGNAVOX "family," you're entitled to protection by one of the most comprehensive warranties and outstanding service networks in the industry.

What's more, your purchase guarantees you'll receive all the information and special offers for which you qualify, plus easy access to accessories from our convenient home shopping network.

And most importantly you can count on our uncompromising commitment to your total satisfaction.

All of this is our way of saying welcome-and thanks for investing in a MAGNAVOX product.

P.S. Remember, to get the most from your MAGNAVOX product, you must return your Warranty Registration Card within 10 days. So please mail it to us right now!

Know these **safety** symbols



⚡ This "bolt of lightning" indicates uninsulated material within your unit may cause an electrical shock. For the safety of everyone in your household, please do not remove product covering.

⚠ The "exclamation point" calls attention to features for which you should read the enclosed literature closely to prevent operating and maintenance problems.

WARNING: TO PREVENT FIRE OR SHOCK HAZARD, DO NOT EXPOSE THIS EQUIPMENT TO RAIN OR MOISTURE.

CAUTION: To prevent electric shock, match wide blade of plug to wide slot, fully insert.

ATTENTION: Pour éviter les choc électriques, introduire la lame la plus large de la fiche dans la borne correspondante de la prise et pousser jusqu'au fond.

For Customer Use

Enter below the Serial No. which is located on the rear of the cabinet. Retain this information for future reference.

Model No. _____
 Serial No. _____

Visit our World Wide Web Site at <http://www.magnavox.com>

Introduction 3

Welcome to your TV/VCR owner's manual.

This manual describes the MC09D5MG TV/VCR and explains how to use all the features listed below.

Features

- Automatic Channel Setup
- Automatic Head Cleaner
- Automatic Tracking Adjustment
- Daylight-Savings Time
- English or Spanish displays
- High Quality (HQ) System
- One-Touch Recording
- Real-Time Tape Counter
- Remote Control or Front Panel menu access
- Rental Playback
- Repeat Play
- ShowGuard™ - Indefinite Timer Recording memory
- Sleep Timer
- Special Effects: Forward and Reverse Searching; Still
- Timer Recording
- Timer Search
- Wake Up Timer
- Zero Return

Safety Precautions

Warning: To prevent fire or shock hazard, do not expose this equipment to rain or moisture.

Federal Communications Commission (FCC) Warning: Any unauthorized changes or modifications to this equipment void the user's authority to operate it.

This equipment has been tested and found to comply with the limits for a Class B digital device, pursuant to Part 15 of the FCC Rules. These limits are designed to provide reasonable protection against harmful interference in a residential installation. This equipment generates, uses, and can radiate radio frequency energy and, if not installed and used in accordance with the instructions, may cause harmful interference to radio communications.

However, there is no guarantee that interference will not occur in a particular installation. If this equipment does cause harmful interference to radio or television reception, which can be determined by turning the equipment off and on, the user is encouraged to try to correct the interference by one or more of the following measures:

1. Reorient or relocate the receiving antenna.
2. Increase the separation between the equipment and receiver.
3. Connect the equipment into an outlet on a circuit different from that to which the receiver is connected.
4. Consult the dealer or an experienced radio/TV technician for help.

Magnavox recommends you use only video cassette tapes that have the **VHS** mark. Other tapes may cause poor picture quality and excessive deposits on the video heads that the warranty may not cover if damage occurs.

This TV/VCR has a High Quality (HQ) system and is compatible with existing Video Home System (VHS) equipment.

Note to the Cable TV System Installer: This reminder calls the Cable TV system installer's attention to Article 820-40 of the National Electrical Code, which provides guidelines for proper grounding – in particular, specifying that the cable ground shall be connected to the grounding system of the building, as close to the point of cable entry as possible.

Declaration of Conformity

Model Number: MC09D5MG
 Trade Name: Magnavox
 Responsible Party: Philips Consumer Electronics
 P.O. Box 14810
 Knoxville, TN 37914-1810
 (865) 521-4316



As an ENERGY STAR® Partner, Magnavox has determined that this product meets the ENERGY STAR® guidelines for energy efficiency. ENERGY STAR® is a U.S. registered mark. Using products with the ENERGY STAR® label can save energy. Saving energy reduces air pollution and lowers utility bills. SmartClock™, SmartLock™, and ShowGuard™ are trademarks of Philips Consumer Electronics. Copyright 2002 Magnavox. All rights reserved.

4 Table of Contents

Setting Up Your TV/VCR

Introduction	3
Table of Contents	4
Before Using the TV/VCR	5
Hooking Up the TV/VCR	6-7
Setting TV Channels for the First Time	8
Selecting a Menu Language	9
Resetting TV Channels	10
Adding/Deleting Channels	11
Setting the Clock	12-15
Daylight-Savings Time	16

Description of Controls

Remote Control Buttons	17
Front Panel	18
Rear Panel	19
On-Screen Status Displays	20
Adjusting the Picture Controls	21

Basic Operations

Playing	22
Playback Options	23
Recording	24

Recording Options

One-Touch Recording	25
Timer Recording	26-28
Timer Recording Auto Return	29
Rerecording (Tape Duplication)	30

Playing Options

Repeat Play	31
Rental Playback	32
Zero Return	33
Time Search	34

Additional Features

Sleep Timer	35
Wake Up Timer	36
Automatic Operation Features	37

Information You May Need

Helpful Hints	38-39
Glossary	40
Specifications	41
Limited Warranty	42
Index	43
Accessories	44

Before Using the TV/VCR 5

Putting Batteries in the Remote Control

- 1** Remove the battery compartment lid on the bottom of the remote control by sliding the lid down and off, following the direction of the arrow on the lid.
- 2** Place two AA batteries inside the battery compartment with their + and - ends aligned as indicated.
- 3** Replace the battery compartment lid.

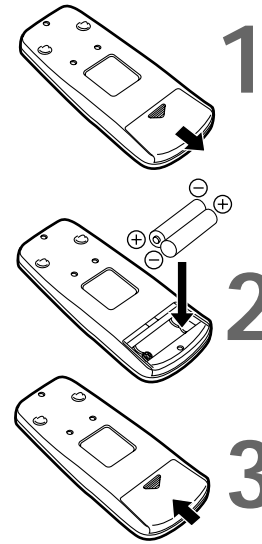

Battery Safety

- Battery Usage CAUTION - To prevent battery leakage that may result in bodily injury or damage to the unit: Install ALL batteries correctly, with the + and - markings on the battery aligned as indicated on the unit; Do not mix batteries, for example, old with new or carbon with alkaline; and Remove batteries when the unit will not be used for a long time.

Recording Prevention

Video cassette tapes have record tabs to ensure you do not erase recordings accidentally.

- 1** To prevent accidental recording, break off the tab with a screwdriver.
- 2** To record again, cover the hole with cellophane tape.

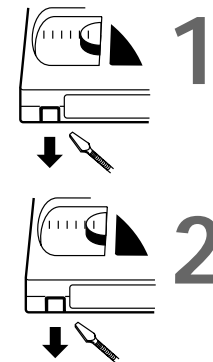

Using the Remote Control

- Point the remote control at the TV/VCR's remote sensor.
- Do not put objects between the remote control and the TV/VCR.

TV/VCR Maintenance

- In this TV/VCR, use only tapes with the **VHS** mark.
- Remove any light adhesive stick-on notes from the video cassette tape before putting the tape in the TV/VCR. Removable labels can jam the TV/VCR.
- The TV/VCR requires periodic maintenance to maintain its excellent performance. This TV/VCR has an automatic head cleaning system. However, the video heads will eventually require cleaning or replacement. Only an authorized service center should perform this service.

Helpful Hint

- Your new product, its packaging, and this manual contain materials that can be recycled and reused. Specialized companies can recycle your product to increase the amount of reusable materials and to minimize the amount that needs to be properly disposed. Your product uses batteries that should not be thrown away when depleted but should be disposed of as small chemical waste. Please find out about the local regulations on disposal of your old product, batteries, manual, and packaging when you replace existing equipment.

6 Hooking Up the TV/VCR

1 Hook up your TV/VCR using one of the connections shown.

A Hooking Up Your TV/VCR With a Cable Signal or Outdoor Antenna

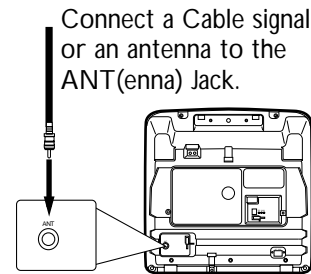

B Hooking Up Your TV/VCR With a Cable Box

To view any channel, set the TV/VCR to the Cable Box output channel (channel 03 or 04). Then, select channels at the Cable Box.

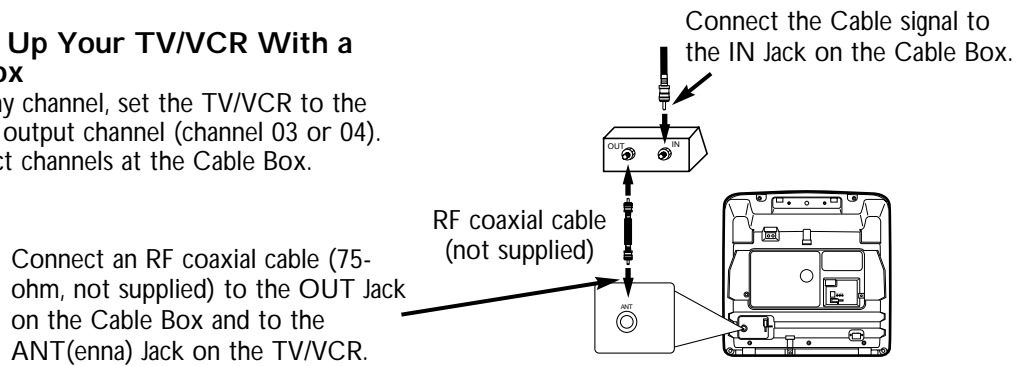

C Hooking Up Your TV/VCR With the Supplied Rod Antenna

To install the supplied rod antenna, push the stem of the antenna into the antenna hole on the back of the TV/VCR. Connect the antenna wire to the ANT(enna) Jack on the back of the TV/VCR as shown. Extend the antenna and adjust its length, direction, and angle for the clearest picture.

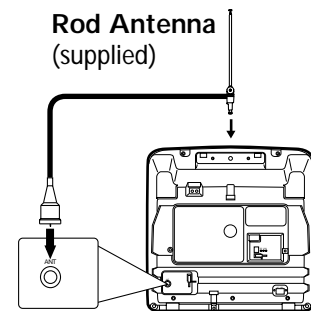

2 Connect the AC power cord to the AC 120V jack on the back of the TV/VCR. Plug the AC power cord into an AC power outlet. Use only the supplied AC power cord.

3 Before you turn on the TV/VCR, go to page eight.

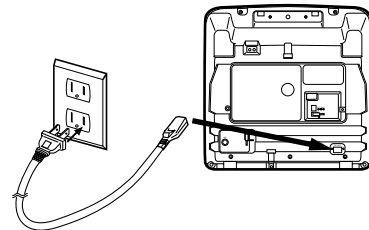

Helpful Hint

- Before connecting an antenna or cable signal to the ANT(enna) Jack, make sure the pin is not bent. If the pin is bent, straighten it as illustrated, then connect the antenna or cable signal to the ANT(enna) Jack.



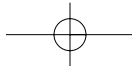

Hooking Up the TV/VCR (cont'd) 7

Mobile Connections

Usually, the supplied rod antenna provides adequate reception. But when you want to watch TV outdoors or in a vehicle, try a mobile antenna (not supplied) or an indoor dipole antenna (not supplied) for better reception.

1

Connect an antenna to the ANT(enna) jack. If you do not use the supplied rod antenna, refer to the instructions with your other antenna to make a connection.

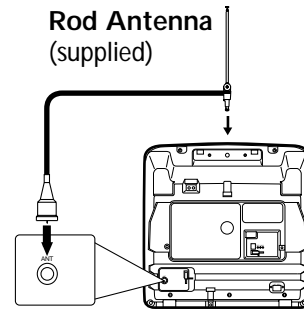

2

Make sure your vehicle has a 13.2-volt, negative ground electrical system. Connect one end of the car battery cord to the DC 13.2V jack on the back of the TV/VCR. Then connect the other end of the car battery cord to the cigarette lighter in your vehicle.

Use only the supplied car battery cord. Using another cord could damage the TV/VCR. Make sure you push the car battery cord's plug completely into the cigarette lighter.

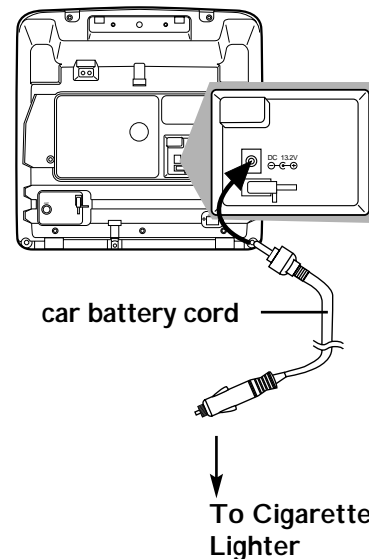

Fuse Replacement

If the TV/VCR does not have power when connected properly in your vehicle, replace the fuse in the car battery cord.

Use only a 5-amp, 250-volt, fast blow fuse, which is available at an electronics retailer.

1



To remove the old fuse, unscrew the red cap from the end of the cord. Place your fingers on the grooved part of the cap and turn the cap counter-clockwise.

2

When the cap is removed, the red cap and the silver tip will be loose. The fuse will be loose inside the end of the cord.

3



Remove the old fuse and insert a new fuse.

4

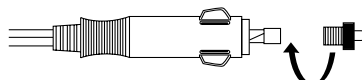

Replace the red cap and the silver tip. The fuse will tighten into place as you screw on the cap, turning the cap clockwise. (The end of the fuse will fit into the silver tip, which is in the center of the red cap when tightened.)

Helpful Hints

- Do not watch TV while driving.
- Make sure the cigarette lighter jack is free of ashes and other debris.
- Always unplug the car battery cord from the cigarette lighter before you unplug it from the TV/VCR.
- You must disconnect the car battery cord from the TV/VCR before you can use standard electrical (AC) power.
- If you use the TV/VCR with the vehicle's engine off, recharge the vehicle's battery often. Unplug the car battery cord from the cigarette lighter when you finish using the TV/VCR.
- When you use the TV/VCR with a car battery cord, noise may appear on the TV/VCR screen.
- Do not use this TV/VCR in high temperature conditions. Details are on page 41.

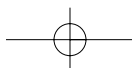
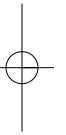
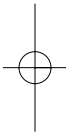

8 Setting TV Channels for the First Time

The TV/VCR can memorize the channels you receive in your area. If you are using a Cable Box or Satellite Box, you do not need to set channels at the TV/VCR. Set the TV/VCR to the output channel of the Cable Box or Satellite Box (channel 03 or 04). Then select the channel to be viewed on the Cable Box or Satellite Box.

If you do not see these menus when you turn on the TV/VCR, set TV channels as instructed on page 10 instead.

1 Press **POWER** to turn on the TV/VCR.

2 Press **F.FWD/▶** or **REW/◀** to select **ENGLISH** or **ESPAÑOL** (Spanish). The selected language will appear inside the [].

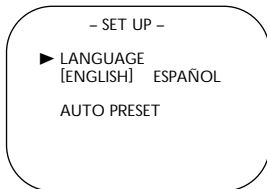

3 Press **PLAY/▲** or **STOP/▼** to select **AUTO PRESET**. Then press **F.FWD/▶**. The TV/VCR scans and memorizes all active channels in your area. When scanning is complete, the TV/VCR will go to the lowest available channel automatically. Use the **CH(annel) ▲/▼** buttons to select memorized channels. Use the **Number** buttons to select non-memorized channels.

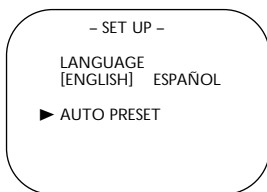

Helpful Hints

- The TV/VCR distinguishes between standard TV channels and cable channels.
- To play or record a video tape before setting TV channels, press the **MENU** button on the remote control. To set up channels later, see *Resetting TV Channels* on page 10.
- To select cable channels higher than 99, press the **+100** button, then press the **Number** buttons for the last two digits. For example, to select channel 125, press **+100**, **2**, **5**. Precede single-digit channel numbers with a zero (for example, **01 ... 09**).

Selecting a Menu Language 9

This function affects only the language of the TV/VCR's menu, not the audio of TV programming or video tapes.

- 1 Press **MENU**. Press **PLAY/▲** or **STOP/▼** to select **LANGUAGE**.

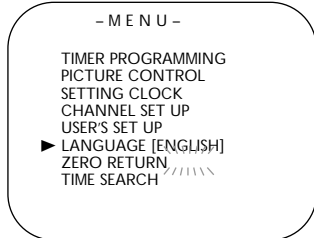

- 2 Press **F.FWD/▶** or **REW/◀** to select **ENGLISH** or **ESPAÑOL (Spanish)**. The selected language will appear inside the [].
- 3 Press **MENU** to remove the menu.

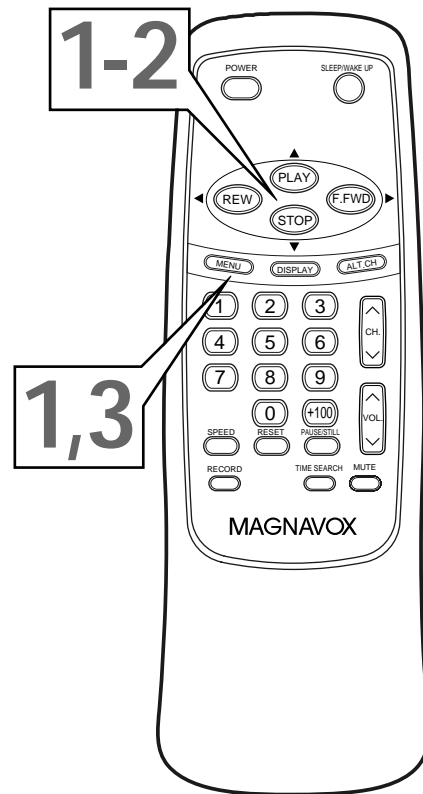

Helpful Hint

- If the menu is in Spanish but you prefer English, press **MENU**, then press **PLAY/▲** or **STOP/▼** to select **IDIOMA [ESPAÑOL]**, then press **F.FWD/▶** to select **[ENGLISH]**. Press **MENU** to remove the menu.

10 Resetting TV Channels

Although the TV/VCR may automatically memorize the channels you receive when you turn it on for the first time, you may set up channels again by following the steps below.

- 1 Press **MENU**. Press **PLAY/▲** or **STOP/▼** to select **CHANNEL SET UP**. Then, press **F.FWD/▶**.

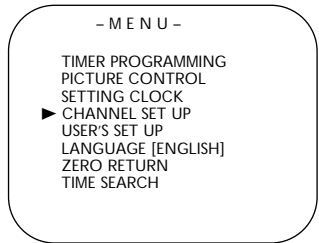

- 2 Press **PLAY/▲** or **STOP/▼** to select **AUTO PRESET**. Then, press **F.FWD/▶**.

The TV/VCR scans and memorizes all the active channels in your area. When scanning is complete, the TV/VCR will go to the lowest available channel automatically. Use the CH(annel) ▲/▼ buttons to select memorized channels. Use the Number buttons to select non-memorized channels.

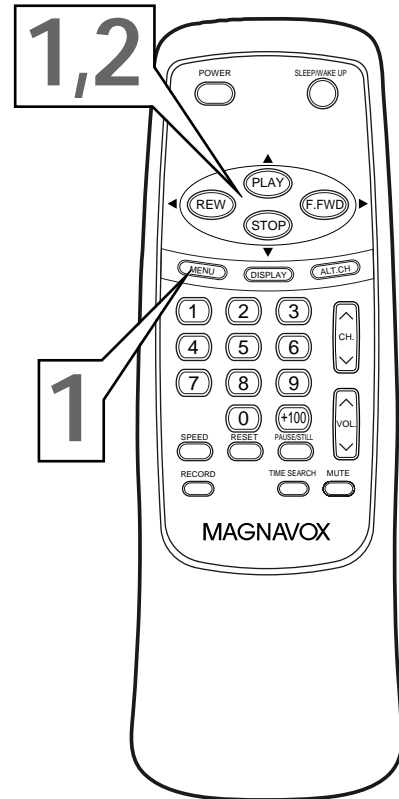
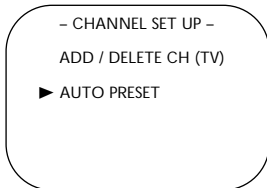

Helpful Hint

- The TV/VCR cannot control or change the channels of the Cable Box or Satellite Box.

Adding/Deleting Channels 11

The channels you no longer receive or seldom watch can be deleted from the memory. (Of course, you can add deleted channels into the memory again.)

- 1 Press **MENU**. Press **PLAY/▲** or **STOP/▼** to select **CHANNEL SET UP**. Then, press **F.FWD/▶**.

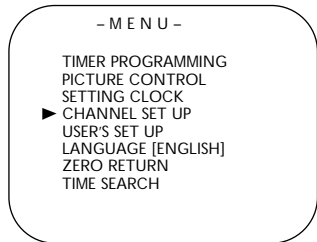

- 2 Press **PLAY/▲** or **STOP/▼** to select **ADD/DELETE CH**. Then, press **F.FWD/▶**.

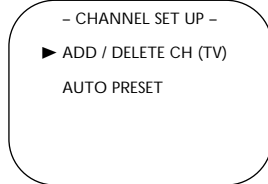

- 3 Press **PLAY/▲** or **STOP/▼** until the channel number you wish to add or delete appears. You also can use the Number buttons or the CH(annel) ▲/▼ button to enter it.

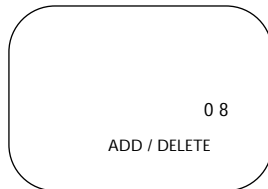

- 4 Press **F.FWD/▶** or **REW/◀** to add or delete the channel. Deleted channels will appear in light red. Added channels will appear in light blue. To delete another channel, repeat steps 3-4.

- 5 Press **MENU** to remove the menu.

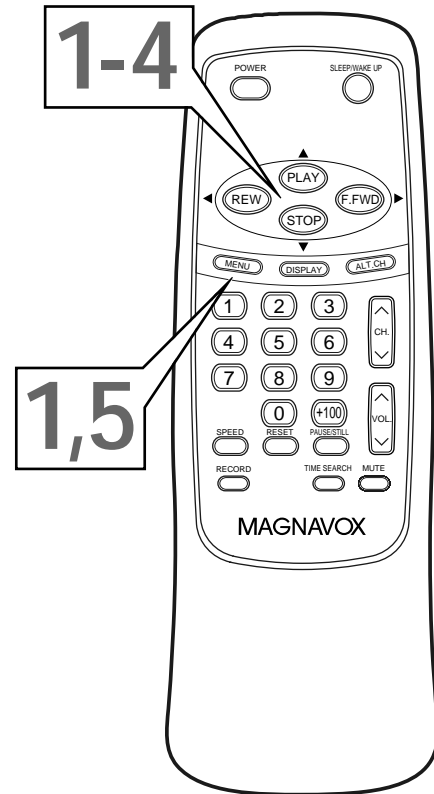

Helpful Hint

- To confirm that a channel has been added or deleted, press the CH(annel) ▲/▼ button to see if you can or cannot select the channel. Only memorized or added channels can be selected with CH(annel) ▲/▼.

12 Setting the Clock

Set the clock accurately for proper timer recording. If a Public Broadcasting Station (PBS) is available in your area, follow Auto Clock Setting below. If not, follow Manual Clock Setting on pages 14-15.

Auto Clock Setting

You can have the TV/VCR set the clock automatically by using the PBS channel in your area. Once you have set the clock, the TV/VCR will automatically monitor the correct time and date being broadcast by the PBS station.

Before you begin, make sure ...

- The TV/VCR power is on.
- The antenna/Cable TV connections are correct.
- The Cable Box is on (if applicable). (See Helpful Hints.)
- Channels are set. *Details are on pages eight and 10.*

1 Press **MENU**. Press **PLAY/▲** or **STOP/▼** to select **SETTING CLOCK**, then press **F.FWD/▶**.

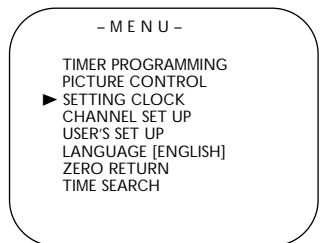

2 With **AUTO CLOCK** selected, press **F.FWD/▶** or **REW/◀** repeatedly until **[ON]** appears beside **AUTO CLOCK**.

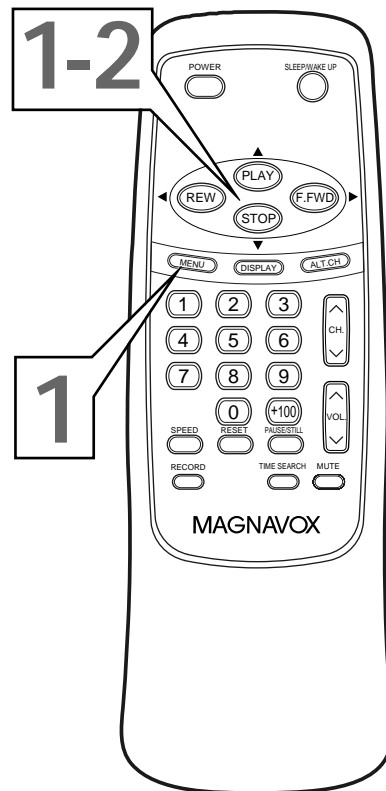
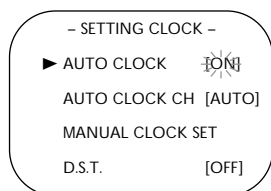

Helpful Hints

- If the TV/VCR is connected directly to a Cable Box or Satellite Box, select the local PBS station on the Cable Box. Set the TV/VCR to the output channel of the Cable Box or Satellite Box (usually channel 3 or 4), to set the clock automatically.
- The TV/VCR cannot control or change the channels of the Cable Box or Satellite Box.
- If you use the mobile connections described on page seven, you cannot use the AUTO CLOCK function.

Setting the Clock (cont'd) 13

- 3** Press **PLAY/▲** or **STOP/▼** to select **AUTO CLOCK CH.** Then press **F.FWD/▶** or **REW/◀** until the channel number of your local PBS station appears.

If you do not know the PBS channel number, leave it set to [AUTO], which is located before [2]. The TV/VCR will automatically search all available channels for the local PBS station and will select that channel.

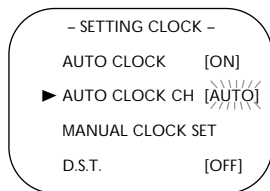

- 4** Press **MENU** to remove the menu.

- 5** Press **POWER** to turn off the TV/VCR.

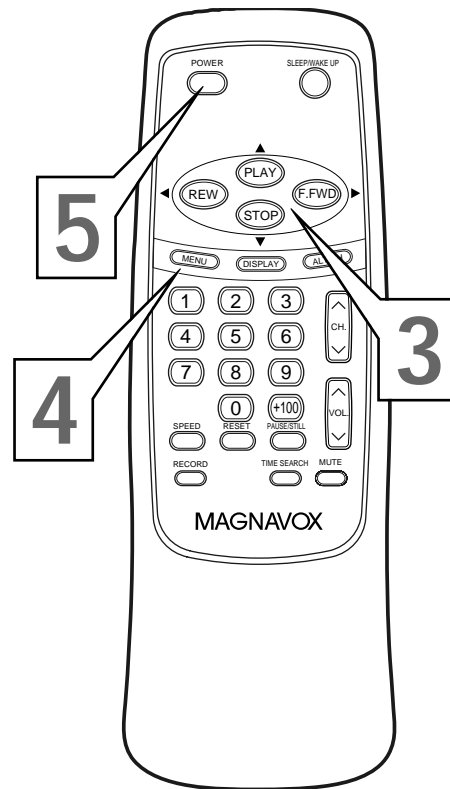

Helpful Hint

- If the TV/VCR sets the time incorrectly, it may have taken the time from a PBS station in a different time zone. Enter the correct local PBS station manually at step 3 or follow the steps for Manual Clock Setting on pages 14-15.

14 Setting the Clock (cont'd)

Manual Clock Setting

- 1 Press MENU. Press PLAY/▲ or STOP/▼ to select SETTING CLOCK. Then, press F.FWD/▶.

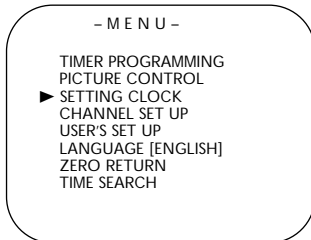

- 2 Press PLAY/▲ or STOP/▼ to select MANUAL CLOCK SET. Then, press F.FWD/▶.

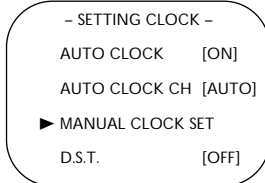

- 3 Press PLAY/▲ or STOP/▼ until your desired month appears. (Example: May → 05) Then, press F.FWD/▶.

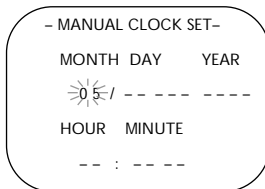

- 4 Press PLAY/▲ or STOP/▼ until your desired day appears. (Example: 7th → 07) Then, press F.FWD/▶.

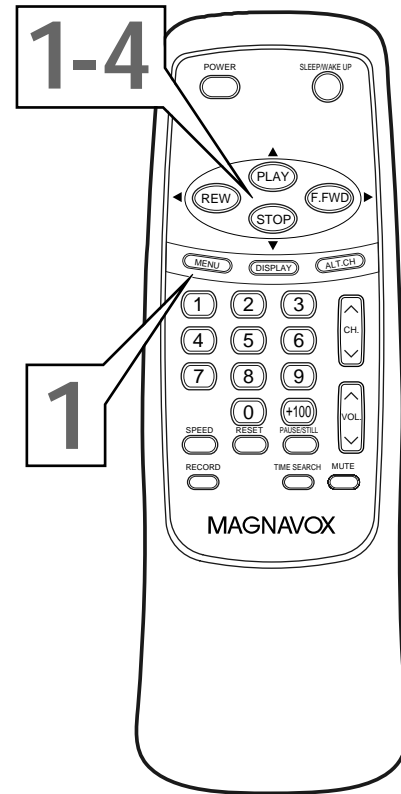
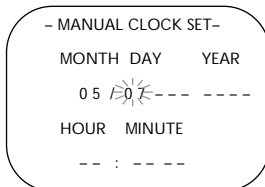

Helpful Hint

- If you unplug the AC power cord or if the power fails for more than three seconds, you may have to reset the clock.
- If there is no PBS station in your area or on your cable system, select AUTO CLOCK and press F.FWD/▶ or REW/◀ to turn [OFF] this function. Then you can set the clock manually.

Setting the Clock (cont'd) 15

- 5** Press **PLAY/▲** or **STOP/▼** until your desired year appears. (Example: 2002) Then, press **F.FWD/▶**.

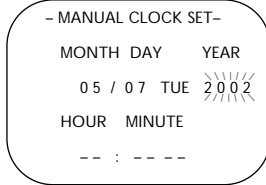

- 6** Press **PLAY/▲** or **STOP/▼** until your desired hour appears. (Example: 05 PM) Then, press **F.FWD/▶**.

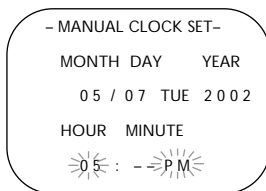

- 7** Press **PLAY/▲** or **STOP/▼** until your desired minute appears. (Example: 40)

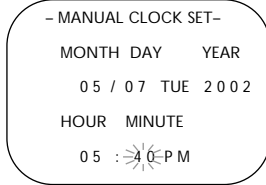

- 8** Press **MENU**. Although seconds are not displayed, they begin counting from 00 when you press **MENU** on the remote control. Use this feature to synchronize the clock with the correct time.

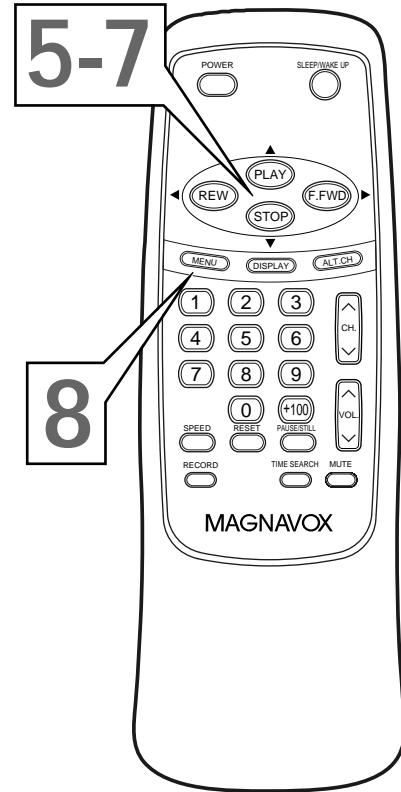
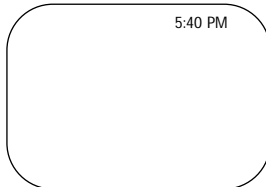

Helpful Hint

- To adjust the clock later, follow steps 1-2 on page 14. Then, press **F.FWD/▶** or **REW/◀** to select the item you want to change. Enter the correct information by pressing **PLAY/▲** or **STOP/▼**. Press **MENU** when you are finished.

16 Daylight-Savings Time

When Daylight-Savings Time (D.S.T.) is ON, the TV/VCR clock will automatically move forward one hour on the first Sunday in April and move back one hour on the last Sunday in October.

To turn Daylight-Savings Time ON or OFF, follow the steps below.

- 1 Press **MENU**. Press **PLAY/▲** or **STOP/▼** to select **SETTING CLOCK**. Then, press **F.FWD/▶**.

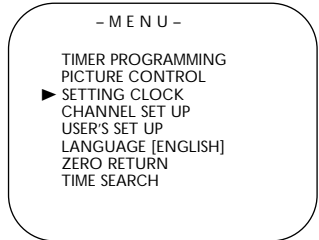

- 2 Press **PLAY/▲** or **STOP/▼** to select **D.S.T.**. Then press **F.FWD/▶** or **REW/◀** until **[ON]** or **[OFF]** appears.

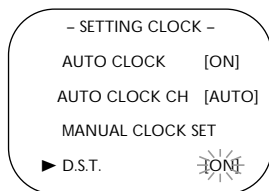

- 3 Press **MENU** to remove the menu.

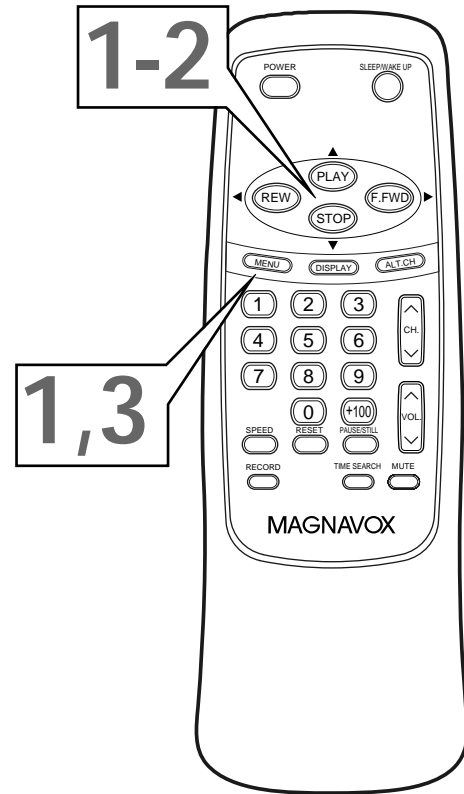

Helpful Hint

- If you use the mobile connections described on page seven, you cannot use the D.S.T. function.

Remote Control Buttons 17

PLAY/▲ Button

Press to play a tape. *Details are on page 22.* Press to select a menu item. Press to enter digits when setting a timer recording or the clock.

POWER Button

Press to turn on or off the TV/VCR.

REW/◀ (rewind) Button

When tape playback is stopped, press to rewind the tape at high speed. During tape playback, press to rewind the tape while the picture stays on the screen. *Details are on page 23.* Press to select a menu item.

F.FWD/▶ (fast forward) Button

When tape playback is stopped, press to fast forward the tape at high speed. During tape playback, press to fast forward the tape while the picture stays on the screen. *Details are on page 23.* When setting the clock or a timer recording, press to confirm information and proceed to the next step. Press to select a menu item.

Number Buttons

Use to select channels for viewing or recording. *Details are on page 8.*

SPEED Button

Press to select the recording tape speed (SP or SLP). *Details are on page 24.*

RECORD Button

Press once to start a recording. *Details are on page 24.*

RESET Button

Press to reset the counter to 0:00:00. *Details are on page 33.*

SLEEP/WAKE UP Button

Press to set the Sleep Timer. *Details are on page 35.* Press to set the Wake Up Timer. *Details are on page 36.*

STOP/▼ Button

Press to stop the tape. Press to select a menu item. Press to enter digits when setting the clock or a timer recording.

ALT. CH (Alternate Channel) Button

Press to return to the TV channel you were viewing previously.

DISPLAY Button

Press to display the counter or the current channel number and current time on the TV screen. *Details are on page 20.*

MENU Button

Press to display the main menu.

CH(annel) ▲/▼ Button

Press to scan through the TV/VCR's available channels.

VOL(ume) ▲/▼ Button

Press to adjust the sound level. Pressing VOL(ume) ▲/▼ when the sound is muted will restore the sound.

MUTE Button

Press to eliminate the TV/VCR's sound. Press again to return to the previous volume level.

TIME SEARCH Button

Press to activate a Time Search. *Details are on page 34.*

PAUSE/STILL Button

Press to pause recording. Press again to resume recording. *Details are on page 24.* During tape playback, press to freeze the picture (still). *Details are on page 23.*

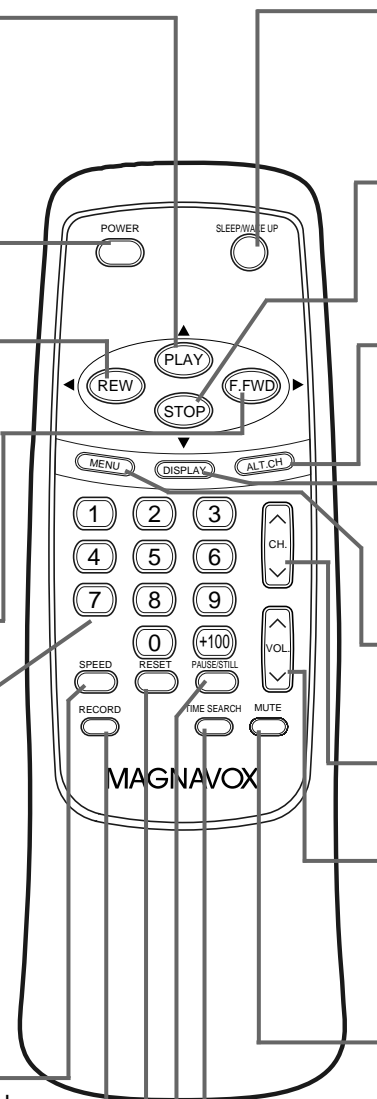

18 Front Panel

Cassette Compartment

Insert a video cassette tape here.

Remote Sensor

Receives a signal from your remote so you can operate the TV/VCR from a distance.

REC(ord) Light

This light flashes during a recording. It lights up when the TV/VCR power is off for a timer recording. It blinks rapidly when a recording is paused.

VIDEO In Jack

Connect this jack to the video out jack of a camcorder or another VCR. *Details are on page 30.*

AUDIO In Jack

Connect this jack to the audio out jack of a camcorder or another VCR. *Details are on page 30.*

POWER Button

Press to turn the TV/VCR on or off. Turn off the TV/VCR to activate a timer recording.

STOP/EJECT Button

Press once to stop the tape. When playback is stopped, press to eject the tape. Press to select an item in the menu.

REW (rewind) Button

When tape playback is stopped, press to rewind the tape at high speed. During playback, press to rewind the tape while the picture stays on the screen. Press to change a setting of a menu item (for example, to adjust the BRIGHTNESS) or to return to a previous menu.

PLAY Button

Press to play a tape. *Details are on page 22.*

F.FWD (Fast Forward) Button

When tape playback is stopped, press to fast forward the tape at high speed. During playback, press to fast forward the tape while the picture stays on the screen. Press to change a setting of a menu item (for example, to adjust the BRIGHTNESS) or to advance to the next menu.

REC/OTR (record/one-touch recording) Button

Press once to start a recording. *Details are on page 24.* Press repeatedly to start a One-Touch Recording (an immediate timed recording, 30 minutes to eight hours long) of the channel you are watching. *Details are on page 25.*

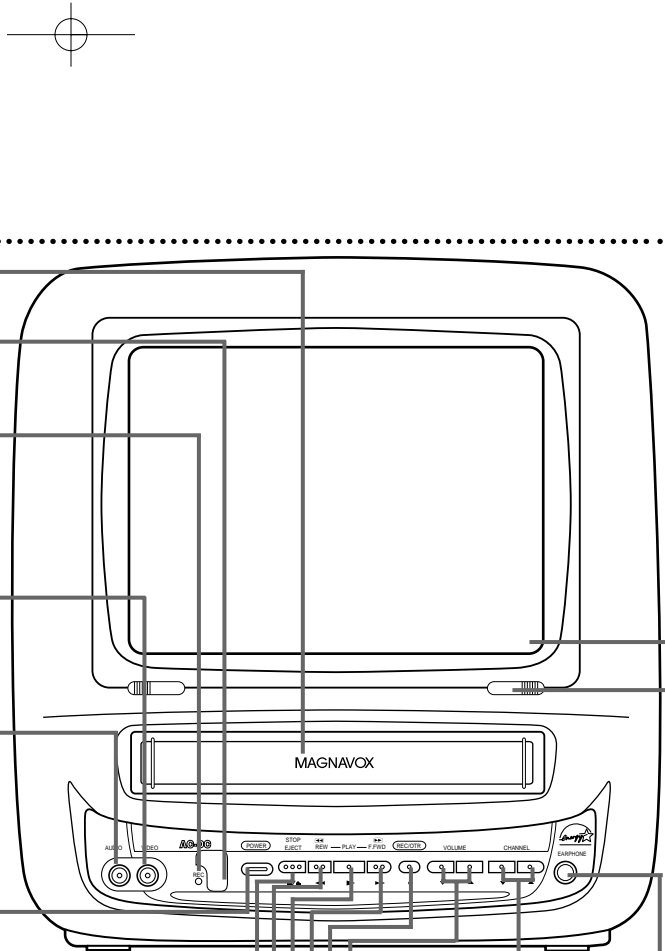

CHANNEL ▲/▼ Buttons

Press to select a TV channel for viewing or recording. To access the TV/VCR's menu, press CHANNEL ▲ while in line input (AUX) mode. Press again to remove the menu. Press to adjust the tracking during tape playback. *Details are on page 37.*

VOLUME ▲/▼ Buttons

Press to adjust the sound level.

EARPHONE Jack

Connect earphones (not supplied) here for personal listening.

Screen Cover

The TV/VCR screen is protected by a removable screen cover. If you want to remove the screen cover, slide in the two tabs that hold the cover in place, then pull off the cover.

Rear Panel 19

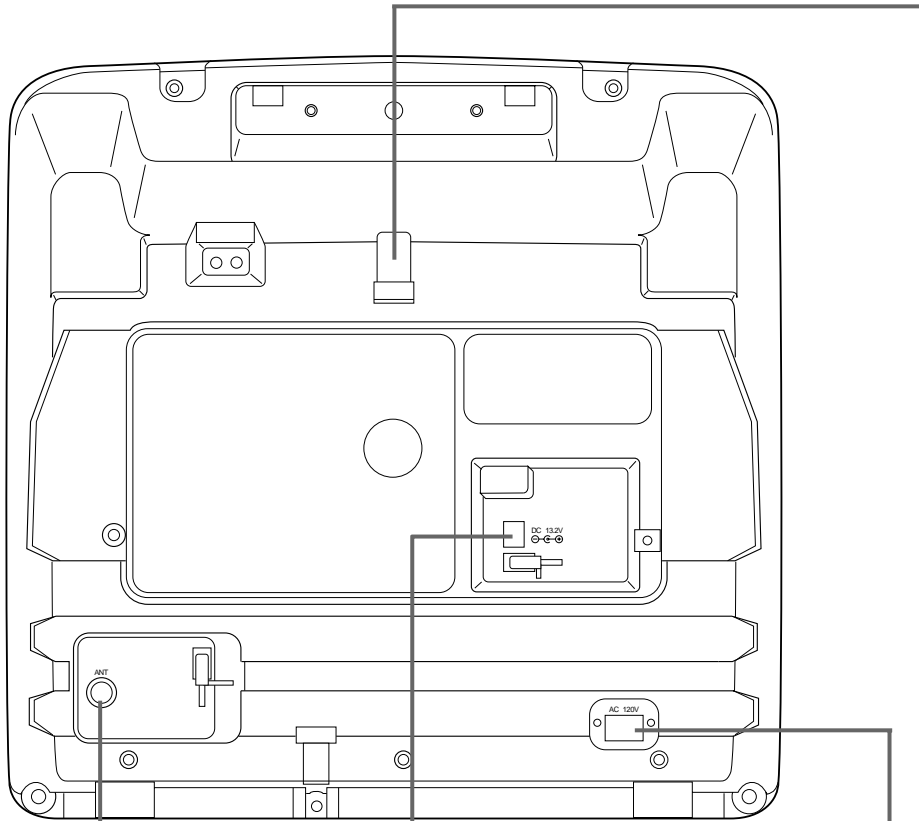

ANT(enna) Jack
Connect your antenna or cable here.
Details are on page six.

DC 13.2V Jack
Connect the car battery cord here.
Details are on page seven.

AC 120V Jack
Connect the AC power cord here.
Details are on page six.

Antenna Hole
Connect the base stem of the supplied
rod antenna here. *Details are on page six.*

20 On-Screen Status Displays

To check the Counter, Clock, and Channel number on the TV screen, press DISPLAY on the remote control. Each time you press DISPLAY, the TV screen will change as described below.

- Counter mode: After five seconds, only the counter remains. To clear it, press DISPLAY.
- Clock mode: After five seconds, only the clock and channel number remain. To clear them, press DISPLAY.

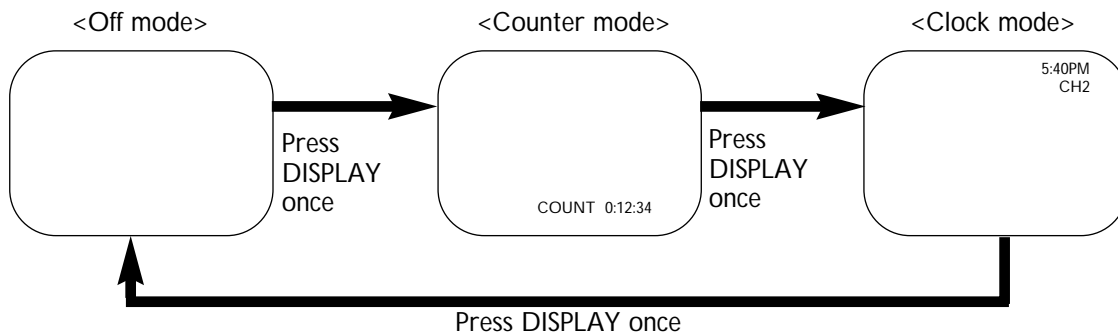

Adjusting the Picture Controls 21

Follow these steps to adjust the TV/VCR's brightness, picture, color, tint, and sharpness.

- 1 Press **MENU**. Press **PLAY/▲** or **STOP/▼** to select **PICTURE CONTROL**. Then, press **F.FWD/▶**.

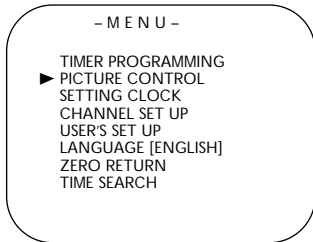

- 2 Press **PLAY/▲** or **STOP/▼** until the desired control is displayed. You can select **BRIGHT**, **CONTRAST**, **COLOR**, **TINT**, or **SHARPNESS**.

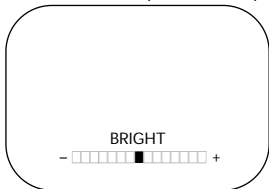

- 3 Press **F.FWD/▶** or **REW/◀** to adjust the control.

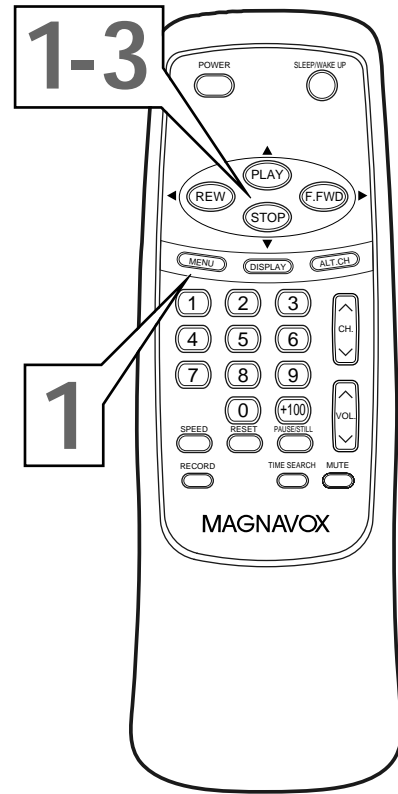

	REW/◀	F.FWD/▶
BRIGHT	decreased brightness	increased brightness
CONTRAST	decreased contrast	increased contrast
COLOR	paler	more brilliant
TINT	more purple	more green
SHARPNESS	softer	more clear

Helpful Hints

- If you do not begin changing an adjustment within five seconds of selecting a control, the Picture Control menu will disappear.
- The original settings will probably give you the best picture quality.
- The TV/VCR will retain the Picture Control settings even if the power fails.

22 Playing

Follow the steps below to play a tape.

- 1** **Insert a tape in the TV/VCR.**
The power will come on. If the tape's record tab is missing, playback should start automatically.
- 2** **If playback does not start automatically, press PLAY/▲ to start playback.**
- 3** **Press STOP/▼ to stop playback.**
- 4** **Press REW(ind)/◀ to rewind the tape.**
- 5** **When the tape finishes rewinding, press STOP/EJECT on the TV/VCR to remove the tape.**

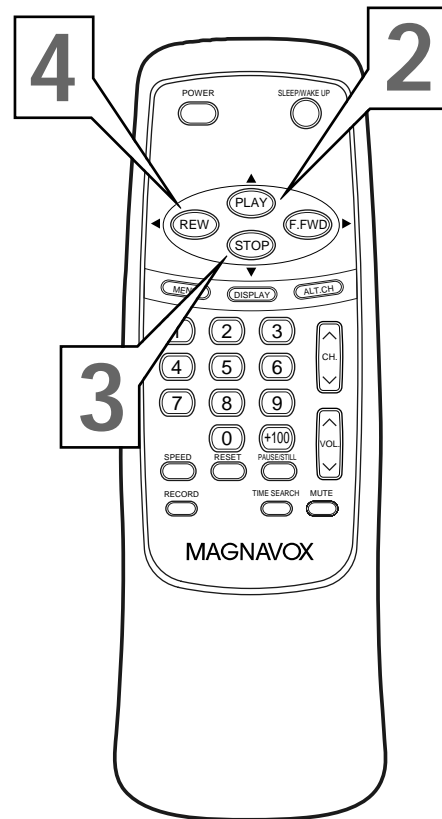

Helpful Hints

- If the tape you want to play is already in the TV/VCR, turn on the TV/VCR power, then press PLAY/▲.
- Playback features and options are on pages 23 and 31-34.
- When you play an S-VHS format tape, you cannot get the high resolution that would be available on an S-VHS VCR. Noise lines (black and white streaks) may appear in the picture.

Playback Options 23

Forward and Reverse Searching (SP/LP/SLP)

- 1 During tape playback, press and release F.FWD/▶ or REW(ind)/◀. A fast forward or reverse picture search will begin.
- 2 To return to normal playback, press PLAY/▲.

Super High Speed Searching (LP/SLP)

- 1 During tape playback, press F.FWD/▶ or REW(ind)/◀, then press again. The TV/VCR will now search in super high speed. Press F.FWD/▶ or REW(ind)/◀ repeatedly to switch between regular and super high speed searching.
- 2 To return to normal playback, press PLAY/▲.



Viewing a Still Picture

- 1 During tape playback, press PAUSE/STILL. A still picture will appear on the screen. The noise lines will move each time you press PAUSE/STILL.
- 2 To release the still picture and return to normal playback, press PLAY/▲.

Helpful Hints

- Still mode will automatically switch to Stop mode after five minutes to protect the TV/VCR and the tape from damage.
- SP/LP/SLP means this feature will work with tapes recorded in Standard Play, Long Play, or Super Long Play. For details about tape speed, see page 24.
- LP/SLP means this feature will work with tapes recorded in Long Play and Super Long Play. For details on tape speed, see page 24.
- During forward and reverse searching, horizontal noise bars will appear on the TV/VCR screen.
- Tapes recorded in SLP speed will have the clearest picture during forward and reverse searching and Still mode.
- This TV/VCR will only record tapes in SP or SLP. It will play tapes that were recorded in LP on a different device (another VCR, for example).

24 Recording

Read and follow the steps below to record a TV program.

- 1** Place a tape with its record tab intact (see page five) in the TV/VCR. The power will come on. Or, if the tape is already in the TV/VCR, press **POWER** to turn on the TV/VCR, if necessary.
- 2** Press **SPEED** until the desired tape speed appears on the TV/VCR screen. See *tape speed details below*.
- 3** Use **CH(annel) ▲/▼** or the **Number** buttons to select the channel you want to record. You cannot change channels during recording.
- 4** Press **RECORD** once to start recording. The REC(ord) light will glow. If the tape does not have a record tab the TV/VCR will eject the tape. Insert another tape.
- 5** To pause the recording (for example, during commercials), press **PAUSE/STILL**. The REC(ord) light will flash. To resume recording, press **PAUSE/STILL** again or press **RECORD**. The REC(ord) light will glow.
- 6** To stop recording, press **STOP/▼**.

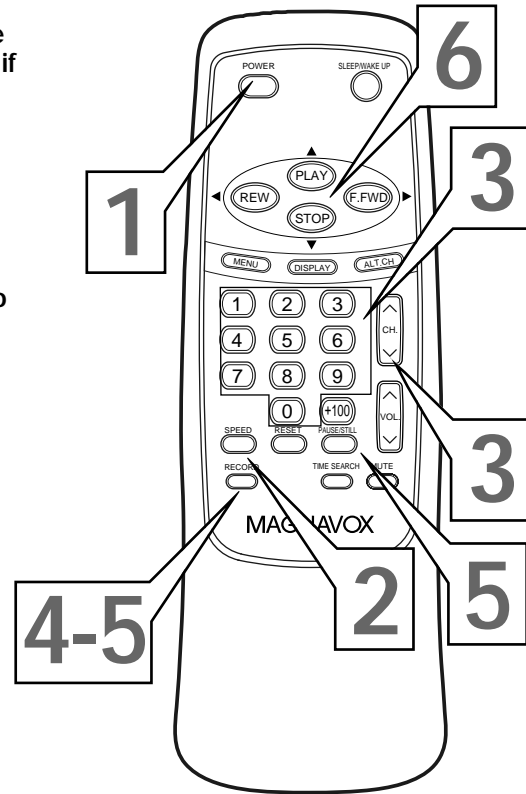

Tape Speeds

This chart shows the recording/playback time for three types of video cassettes (T160, T120, and T60). There are three playback speeds: SP, LP, and SLP. A tape will play only in the speed in which it was recorded. When recording, you can change the tape speed using the **SPEED** button. You cannot record in LP speed.

The slower the speed, the more programming you can fit on the tape. SLP is the slowest speed.

Tape Speed	Cassette type / Playback Time		
	T160	T120	T60
SP(Standard Play)	2 hrs. 40 mins.	2 hrs.	1 hr.
LP(Long Play) (playback only)	5 hrs. 20 mins.	4 hrs.	2 hrs.
SLP(Super Long Play)	8 hrs.	6 hrs.	3 hrs.

Helpful Hints

- You cannot record one channel while watching another.
- Recording options are on pages 25-30.
- If you pause a recording for more than five minutes, the TV/VCR will switch to Stop mode automatically to protect the video cassette tape from damage.
- You can change the tape speed with the **SPEED** button while a recording is in progress, but some distortion may appear on the tape.

One-Touch Recording 25

A One-Touch Recording (OTR) is an immediate timed recording from 30 minutes to eight hours long.

- This function cannot be done from the remote control.
- Recording starts immediately when you press REC/OTR.

Before you begin, make sure ...

- The TV/VCR power is on.
- Insert a cassette tape with its erase prevention tab in place. (If necessary, rewind or fast forward the tape to the point at which you want to begin recording.)

1 Press the Number buttons or CH(annel) ▲/▼ to select the channel you want to record. Remember, if the TV/VCR is connected to a Cable Box or Satellite Box, the TV/VCR must be on channel 3 or 4. Select the channel you want to record at the Cable Box/Satellite Box.

2 Press SPEED to select a tape speed (SP/ SLP). Details are on page 24.

3 Press REC/OTR repeatedly to select a recording length. The recording length will be determined by the number of times you press REC/OTR. Each press of REC/OTR will increase the recording time by 30 minutes. It may be set up to a maximum recording length of eight hours.

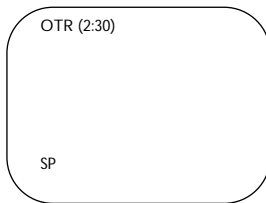

REC/OTR presses	Display	Recording length
1 press		(normal recording)
2 presses	0:30	30 minutes
3 presses	1:00	60 minutes
↓	↓	↓
17 presses	8:00	480 minutes

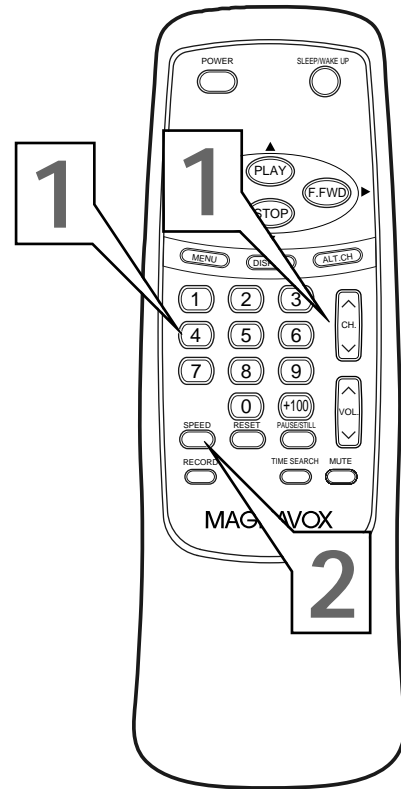

3 Press REC/OTR on the TV/VCR.

Helpful Hints

- If you press REC/OTR 18 times, normal recording resumes.
- To stop an OTR, press STOP/▼.
- To show the remaining time, press DISPLAY. OTR will appear briefly on the TV screen.
- Recording stops when 0:00 is reached.
- The maximum recording time of a T-160 tape in SLP speed is 8 hours (assuming you start at the beginning of the tape). A T-120 tape has a maximum of 6 hours recording time in SLP speed.
- If the tape ends before the recording's end time, the TV/VCR will stop recording, eject the tape, and turn itself off.

26 Timer Recording

Follow the steps below to program the TV/VCR to record TV programs while you're away from home. The TV/VCR will turn itself on, record, and turn itself off automatically.

Before you begin, make sure ...

- The clock is set. If the clock is not set, MANUAL CLOCK SET appears. See page 14 to set the clock, then set the recording.
- Channels are set. *Details are on pages eight and 10.*
- A tape is in the TV/VCR.

1 Press MENU. Press PLAY/▲ or STOP/▼ to select **TIMER PROGRAMMING**. Press F.FWD/▶.

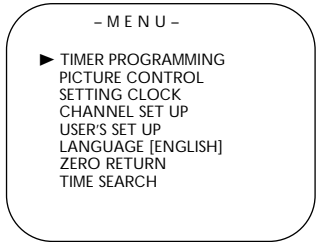

2 Press PLAY/▲ or STOP/▼ to select a program position. Then, press F.FWD/▶.

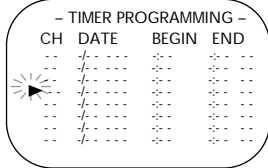

3 Press PLAY/▲ or STOP/▼ until the desired channel number appears. (Example: CH61) Then press F.FWD/▶. If the TV/VCR is connected to a Cable Box or Satellite Box, the TV/VCR must be on CH3 or CH4. Set CH as 03 or 04 in the Timer Programming menu. Select the channel to be recorded on the Cable Box/Satellite Box.

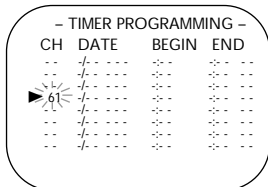

4 For a one-time recording, press PLAY/▲ until the desired date appears.
 Or, to record a TV program at the same time on the same channel every day, press STOP/▼ until **EVERY DAY** appears.
 Or, to record a TV program at the same time on the same channel every week, for example every Monday, press STOP/▼ until **EVERY** and your desired day of the week appear together.
 Finally, press F.FWD/▶.

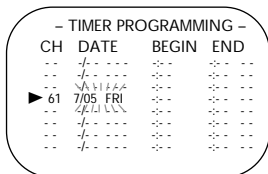

Example:
one-time
recording

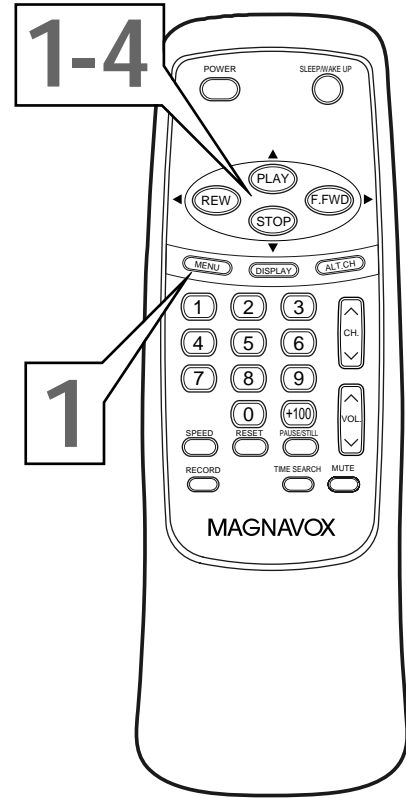

Helpful Hints

- If you are using Timer recording, you may not operate the unit manually.
- The erase-prevention tab on the cassette must be in place (or you must put tape over the hole).
- If the erase-prevention tab is removed, the cassette will eject when you press POWER to turn off the TV/VCR.
- If the tape ends before the recording is complete, the TV/VCR will stop recording immediately and eject the tape.

Timer Recording (cont'd) 27

- 5** Press **PLAY/▲** or **STOP/▼** until the desired beginning hour appears. (Example: 7:12 PM) Then, press **F.FWD/▶**.

- TIMER PROGRAMMING -			
CH	DATE	BEGIN	END
▶ 61	7.05 FRI	7:12	
--	--	--	--
--	--	--	--
--	--	--	--
--	--	--	--
--	--	--	--

- 6** Press **PLAY/▲** or **STOP/▼** until the desired beginning minute appears. (Example: 7:30 PM) Then, press **F.FWD/▶**.

- TIMER PROGRAMMING -			
CH	DATE	BEGIN	END
▶ 61	7.05 FRI	7:30	
--	--	--	--
--	--	--	--
--	--	--	--
--	--	--	--
--	--	--	--

- 7** Press **PLAY/▲** or **STOP/▼** until the desired end hour appears. (Example: 8:30PM) Then, press **F.FWD/▶**.

- TIMER PROGRAMMING -			
CH	DATE	BEGIN	END
▶ 61	7.05 FRI	7:30	8:30
--	--	--	--
--	--	--	--
--	--	--	--
--	--	--	--
--	--	--	--

- 8** Press **PLAY/▲** or **STOP/▼** until the desired end minute appears. (Example: 8:50PM) Press **F.FWD/▶**.

- TIMER PROGRAMMING -			
CH	DATE	BEGIN	END
▶ 61	7.05 FRI	7:30	8:50
--	--	--	--
--	--	--	--
--	--	--	--
--	--	--	--
--	--	--	--

- 9** Press **PLAY/▲** or **STOP/▼** until the desired tape speed appears. (Example: SP)

- TIMER PROGRAMMING -			
CH	DATE	BEGIN	END
▶ 61	7.05 FRI	7:30	8:50 SP
--	--	--	--
--	--	--	--
--	--	--	--
--	--	--	--
--	--	--	--

- 10** Press **F.FWD/▶** or **REW/◀**. To set another program, repeat steps 2-10. Or, press **MENU** to remove the menu.

- 11** Press **POWER** to set the timer recording. The **REC(ord)** light will appear. You must turn off the TV/VCR to activate automatic timer recording. If the power is not off and you continue watching TV, **TIMER REC STANDBY** starts flashing on the TV screen two minutes before the programmed start time.

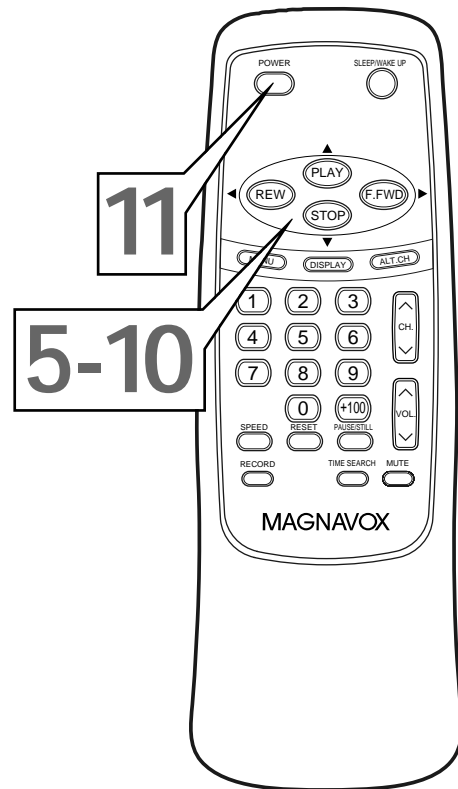

Helpful Hint

- To correct information while setting the Timer Recording, press **REW/◀** to go back one step and select the incorrect information. Press **PLAY/▲** or **STOP/▼** to enter the correct information.

28 Timer Recording (cont'd)

Extending a Timer Recording

To make a Timer Recording start and end later than originally scheduled, follow these steps.

- 1 Press POWER to turn on the TV/VCR.
- 2 Press MENU. Press PLAY/▲ or STOP/▼ to select TIMER PROGRAMMING. Press F.FWD/▶.
- 3 Press RECORD, then press PLAY/▲ or STOP/▼ to select the desired program.
- 4 Press RECORD again. Each press of RECORD will shift forward the beginning/end time by 10 minutes. If the recording is in progress, each press will shift forward the end time only.
If you adjust the times during recording, the recording speed automatically changes to SLP.
To restore the original recording times, press PAUSE/STILL.
- 5 Press F.FWD/▶ or REW/◀, then press MENU to remove the menu.
- 6 If the timer recording is scheduled to start later, press POWER to turn off the TV/VCR for the recording.

Correcting a Timer Recording

- 1 To correct information in a Timer Recording after you have finished setting it, press POWER to turn on the TV/VCR.
- 2 Press MENU. Press PLAY/▲ or STOP/▼ to select TIMER PROGRAMMING. Press F.FWD/▶.
- 3 Press PLAY/▲ or STOP/▼ to select a timer recording, then press F.FWD/▶.
- 4 Press F.FWD/▶ repeatedly to select the information you want to change. Press REW/◀ to go back if necessary. Press PLAY/▲ or STOP/▼ to enter the correct information.
- 5 Press POWER to turn off the TV/VCR again to set the recording.

Cancelling Timer Recordings

To cancel a timer recording that is in progress:

- 1 Press POWER to turn on the TV/VCR, then press STOP/EJECT on the TV/VCR.

To cancel a timer recording that has not started:

- 1 Press POWER to turn on the TV/VCR.
- 2 Press MENU. Press PLAY/▲ or STOP/▼ to select TIMER PROGRAMMING. Press F.FWD/▶.
- 3 Press PLAY/▲ or STOP/▼ to select a timer recording, then press F.FWD/▶.
- 4 Press RESET.
- 5 Press MENU to remove the menu.

Checking Scheduled Timer Recordings

- 1 Press POWER to turn on the TV/VCR. The REC(ord) light will turn off.
- 2 Press MENU. Press PLAY/▲ or STOP/▼ to select TIMER PROGRAMMING if necessary.
- 3 Press F.FWD/▶. The program details will appear on the screen.
- 4 Press MENU to remove the menu.

Timer Recording Auto Return 29

With this feature, after timer recording is finished, the beginning of the recorded program(s) can be searched for automatically.

- 1 Press **MENU**. Press **PLAY/▲** or **STOP/▼** to select **USER'S SET UP**. Then, press **F.FWD/▶**.

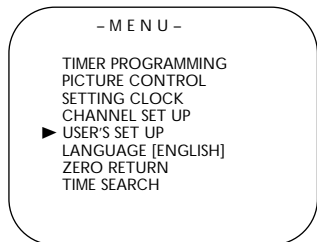

- 2 Press **PLAY/▲** or **STOP/▼** to select **AUTO RETURN**. Press **F.FWD/▶** or **REW/◀** until **[ON]** appears.

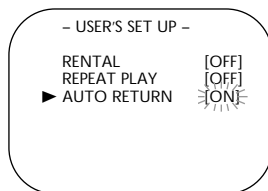

- 3 Press **MENU**. When all the timer recordings are completed, the TV/VCR will rewind to the beginning of the recorded program(s). Press **PLAY/▲** to play the tape from the beginning of the timer recordings.

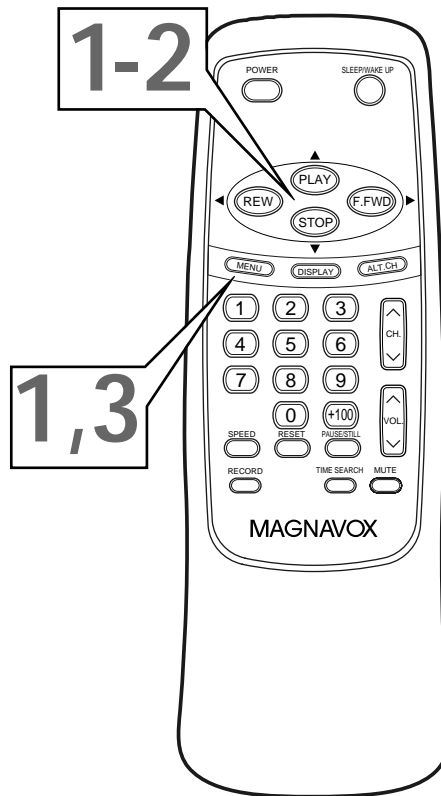

To Cancel Auto Return

Repeat steps 1-2, but select **[OFF]** at step 2 using **F.FWD/▶** or **REW/◀**.

Helpful Hints

- If you press **POWER** while the tape is rewinding, Auto Return will stop.
- If there is a power failure, the TV/VCR will retain its memory for this feature.

30 Rerecording (Tape Duplication)

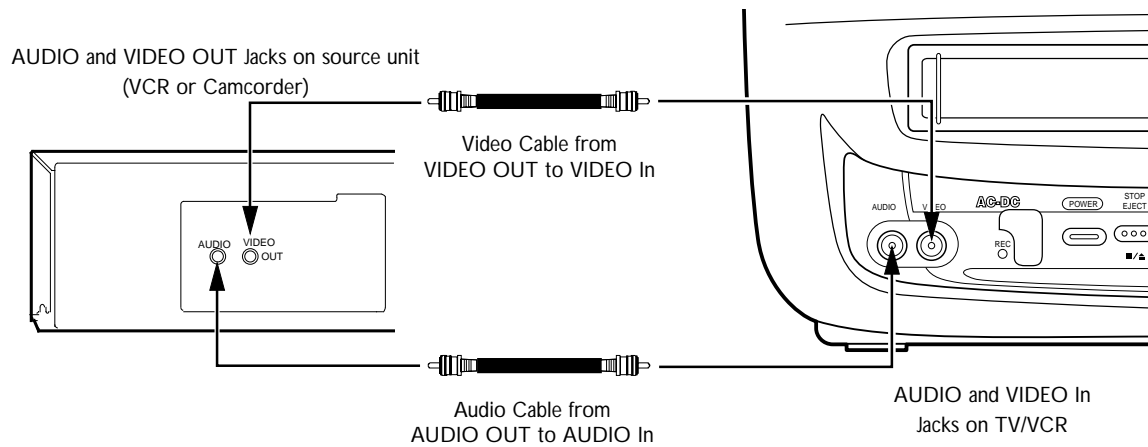

- 1 Make the connections shown above, using audio and video cables (not supplied). Connect the source unit (VCR or camcorder) to a power source after connections are made.
- 2 The VCR or camcorder will play your tape. **Insert a prerecorded tape in the source unit.** If playback begins, press STOP on the unit.
- 3 The TV/VCR will record your tape. **Insert a blank tape in the TV/VCR.** Make sure the tape's record tab is intact. The TV/VCR power will turn on automatically.
- 4 Point the TV/VCR remote control at the TV/VCR. Press Number buttons 0, 0 so that **AUX** appears on the screen. The TV/VCR is now in Line Input or Auxiliary mode.
- 5 Point the TV/VCR remote control at the TV/VCR. Press SPEED until the desired tape speed (SP or SLP) appears on the screen.
- 6 Press PLAY on the source unit and REC(ord)/OTR on your TV/VCR at the same time. Copying will begin.
- 7 To stop copying, press STOP/EJECT on the TV/VCR, then stop the tape on the VCR or camcorder.

Helpful Hints

- Unauthorized recording of copyrighted television programs, video tapes, or other materials may infringe on the rights of copyright owners and violate copyright laws.
- Different brands of equipment may operate differently.
- Make sure all connections are secure. Otherwise, you may not record both picture and sound.
- Programs that are copyright protected may not record clearly.

Repeat Play 31

Repeat Play allows you to repeat a tape indefinitely without using PLAY/▲. ALL REPEAT will repeatedly play the tape from the beginning to the end. BLANK REPEAT will repeatedly play the tape from its beginning to the first part that is blank for more than 10 seconds.

- 1 Press MENU. Press PLAY/▲ or STOP/▼ to select USER'S SET UP. Then, press F.FWD/▶.

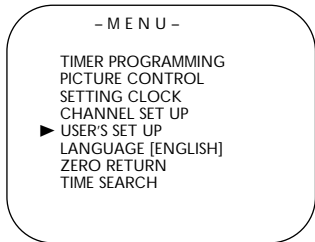

- 2 Press PLAY/▲ or STOP/▼ to select REPEAT PLAY. Press F.FWD/▶ or REW/◀ repeatedly until [ALL] or [BLANK] appears.

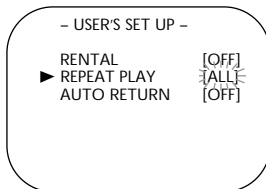

- 3 Press MENU to remove the menu.
- 4 Press PLAY/▲ to start Repeat Play. REPEAT PLAY ▶ appears.

To Cancel Repeat Play

Repeat steps 1-2, but select [OFF] at step 2 using F.FWD/▶ or REW/◀. Press MENU to remove the menu.

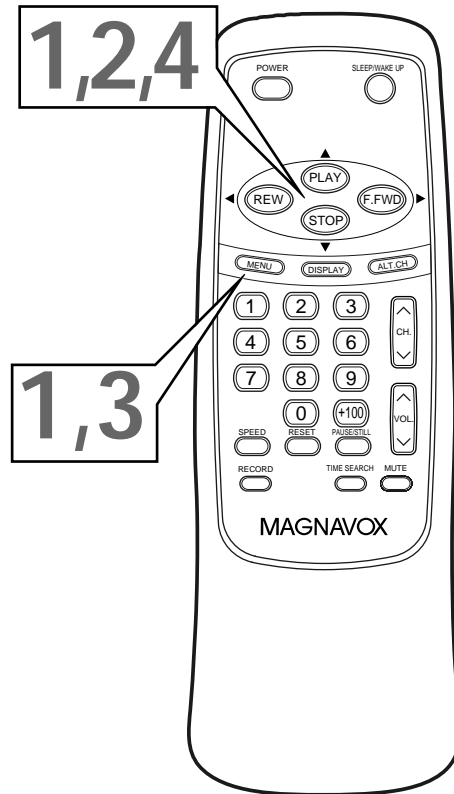

Helpful Hints

- Once you set Repeat Play, it stays in effect even after you turn off the TV/VCR.
- If RENTAL is set to [ON], the RENTAL PLAY ▶ display has priority. Details are on page 32.
- The TV/VCR will retain the Repeat Play setting even if the power fails.

32 Rental Playback

This function enables you to improve picture quality when playing worn cassettes such as rented tapes.

- 1 Press **MENU**. Press **PLAY/▲** or **STOP/▼** to select **USER'S SET UP**. Then, press **F.FWD/▶**.

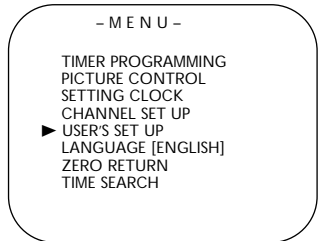

- 2 Press **PLAY/▲** or **STOP/▼** to select **RENTAL**. Press **F.FWD/▶** or **REW/◀** until **[ON]** appears.

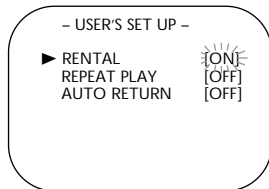

- 3 Press **MENU** to remove the menu.
- 4 Press **PLAY** to start playback. **RENTAL PLAY ▶** appears.

To Cancel Rental Playback

Repeat steps 1-2, but select **[OFF]** at step 2 using **F.FWD/▶** or **REW/◀**. Press **MENU** to remove the menu.

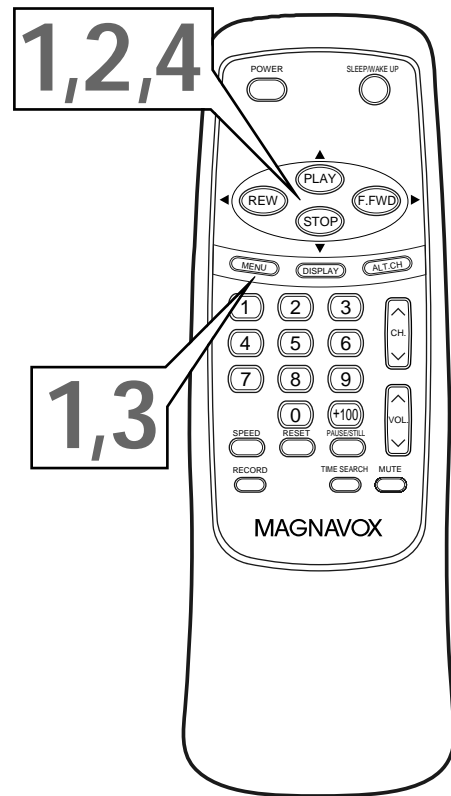

Helpful Hints

- Once you select Rental Playback, it stays in effect even after you turn off the TV/VCR.
- The TV/VCR will retain the Rental setting even if the power fails.

Zero Return 33

Follow the steps below to reset the counter to zero at a tape location you want to refer to later.

- 1** Play, rewind, or fast forward the tape to the location you would like to refer to later. Stop the tape.
- 2** Press RESET to set the counter to 0:00:00.
- 3** Press RECORD (for recording) or PLAY/▲ (for playback). Press STOP/▼ when recording or playback is completed.
- 4** Press MENU. Press PLAY/▲ or STOP/▼ to select ZERO RETURN. Then, press F.FWD/▶. The counter will appear on the screen. When the tape reaches the point at which you set the counter to zero, the tape will stop. Press PLAY/▲ to watch the tape.

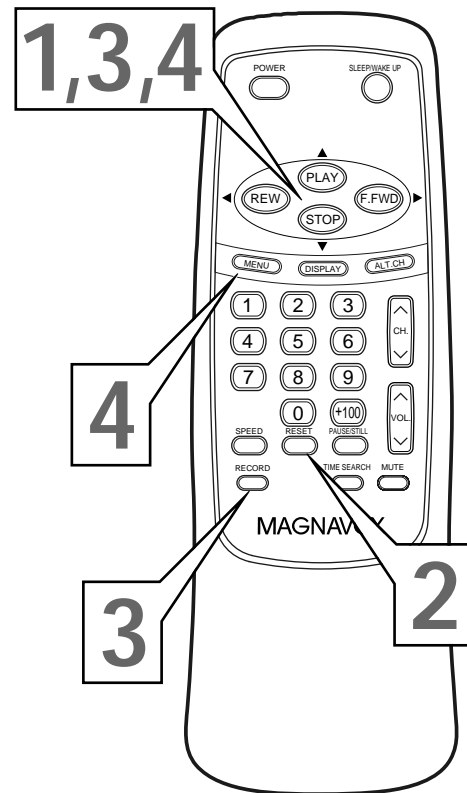
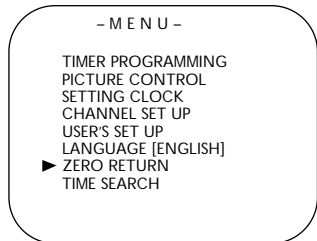

34 Time Search

Time Search lets you quickly advance the tape to a position simply by entering the amount of playback time you want to skip.

In the example below, Time Search is set to 2 hours, 50 minutes from the present position.

- 1** Insert a tape.
- 2** Press **TIME SEARCH**.
- 3** Press **PLAY/▲** or **STOP/▼** until your desired **time appears** (for example, 2:50 for 2 hours 50 minutes). Each press increases the time by 10 minutes. To cancel the Time Search at this point, press **MENU**.

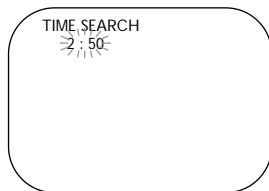

- 4** Press **REW/◀** or **F.FWD/▶**. The TV/VCR will rewind or fast forward the specified amount of time. The time counts down as the search progresses. When 0:00 is reached, the tape will start playback automatically. Or, to cancel the time search before it finishes, press **STOP/EJECT**.

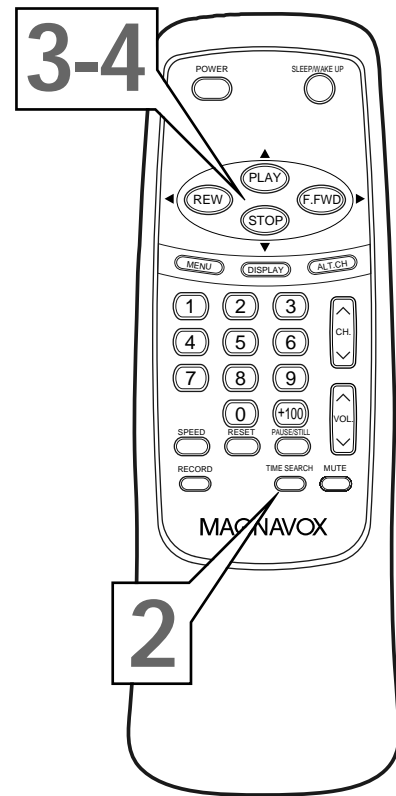

Helpful Hints

- Time Search can be set up to a maximum of 9 hours 50 minutes (9:50), 10 minutes at a time.
- This function will not operate during recording.

Sleep Timer 35

Use the Sleep Timer to program the TV/VCR to shut off in a certain amount of time.

- 1** Press **SLEEP/WAKE UP** until **SLEEP TIMER** appears.
- 2** Press **PLAY/▲**, **STOP/▼**, **F.FWD/▶** or **REW/◀** until your desired sleep time appears. Each button press will increase the time by 30 minutes up to 120 minutes.

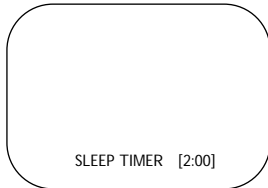

- 3** Press **MENU** to exit the Sleep Timer setting.

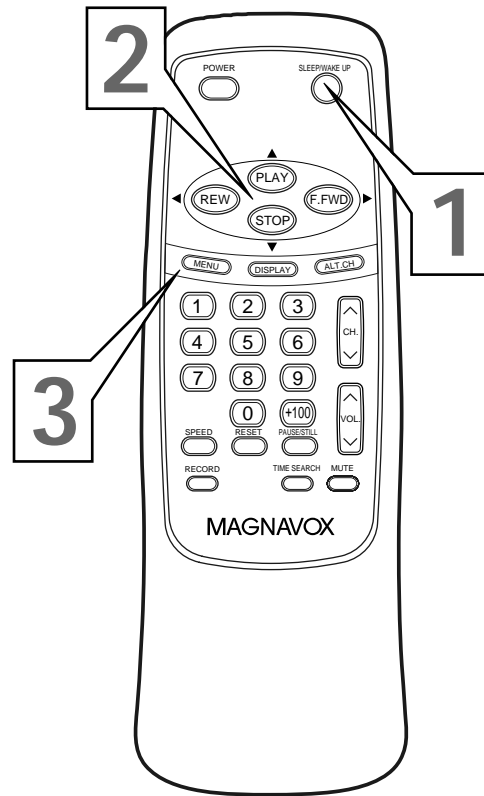

Helpful Hints

- To cancel the Sleep Timer, press **SLEEP/WAKE UP** until **SLEEP TIMER** appears. Press **PLAY/▲**, **STOP/▼**, **F.FWD/▶**, or **REW/◀** to select **OFF**.
- To see how much time remains before the TV/VCR turns itself off, press **SLEEP/WAKE UP** twice, then press **MENU** to exit the Sleep Timer setting.

36 Wake Up Timer

The Wake Up Timer turns on the TV/VCR automatically at a specified time within the next 24 hours. You may set the TV/VCR to turn on at a TV channel or with VCR playback. To set the Wake Up Timer, follow the steps below.

Before you begin:

- Set the clock. *Details are on pages 12-15.* If the clock is not set, you will not be able to set the Wake Up Timer.
- Put a tape in the TV/VCR if you want the TV/VCR to start tape playback at the specified time.

- 1** Press **SLEEP/WAKE UP** until **WAKE UP TIMER** appears. Press **F.FWD/▶** or **REW/◀** until **[ON]** appears.

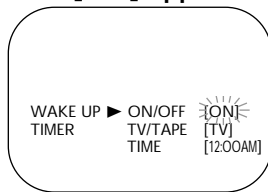

- 2** Press **PLAY/▲** or **STOP/▼** to select **TV/TAPE**. Press **F.FWD/▶** or **REW/◀** to select **[TV]** or **[TAPE]**. If you select **TV**, the current TV channel will be on when the TV/VCR turns on. Select **TAPE** to start tape playback when the TV/VCR turns on.

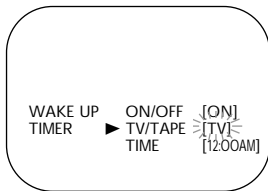

- 3** Press **PLAY/▲** or **STOP/▼** to select **TIME**. Press **F.FWD/▶** or **REW/◀** to select your desired wake up time. Each button press will increase (or decrease) the time by 10 minutes.

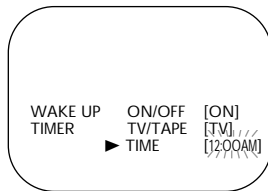

- 4** Press **MENU** to remove the menu, then press **POWER** to turn off the TV/VCR. The TV/VCR will turn on at the specified time.

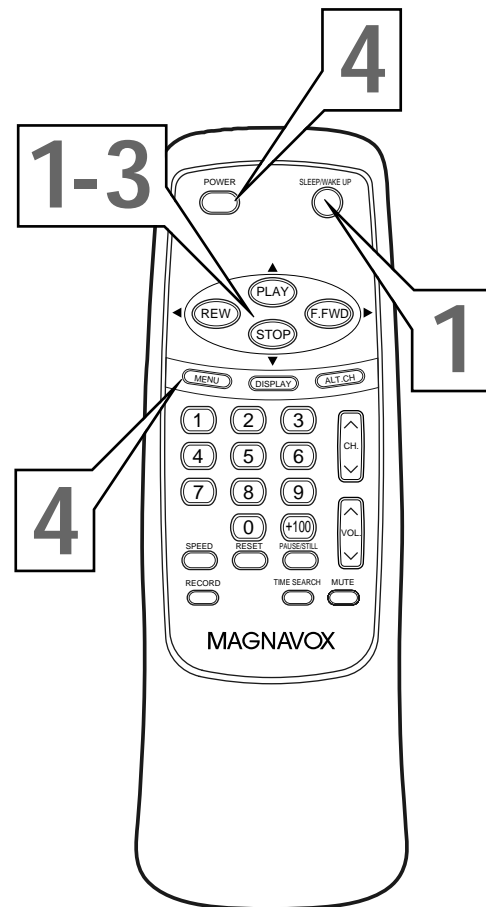

Helpful Hint

- To cancel the Wake Up Timer, press **SLEEP/WAKE UP** until **WAKE UP TIMER** appears, then press **F.FWD/▶** or **REW/◀** until **[OFF]** appears.

Automatic Operation Features 37

The following playback features will always operate.

Automatic Playback

When you put a tape in the TV/VCR, the power will come on automatically. If the tape's record tab is missing, playback will begin. If a timer recording is set, the power will not come on automatically when you insert a tape with the record tab intact. If a timer recording is set and the TV/VCR power is off, the TV/VCR will eject the tape if the record tab is missing.

Automatic Rewind, Eject, Off

When you play, fast forward, or record a tape to its end, the TV/VCR will rewind the tape, stop, turn itself off, and eject the tape.

Tape Eject

A tape can be ejected with the TV/VCR power on or off (but the TV/VCR must be plugged in). If a timer recording is programmed, a tape cannot be ejected when the power is off. Turn on the TV/VCR power, then eject the tape. Be sure to insert a tape and turn off the TV/VCR power for the timer recording.

Automatic Tracking Adjustment

The TV/VCR automatically adjusts the tracking to give you the best possible picture quality. With some recordings, however, you may get a better picture using the manual tracking controls (see below).

Manual Tracking

To adjust the tracking manually, press the CHANNEL ▲/▼ buttons on the TV/VCR or the CH(annel) ▲/▼ button on the remote control during playback.

Tracking returns to Automatic Tracking Adjustment when a tape is inserted or when the STOP/▼ button is pressed.

Before
Tracking
Adjustment

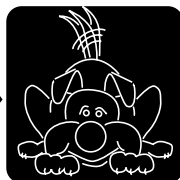
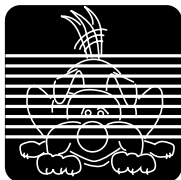

After
Tracking
Adjustment

38 Helpful Hints

If you are having problems with your product, check this list of problems and possible solutions before requesting service. You may be able to solve the problem yourself.

If you need to call a customer service representative, please know the model number and serial number of your product before you call. This information is on the back of the product. Also, please take a moment to identify the problem you are having, and be prepared to explain this to the representative. If the representative will need to help you with operations, please stay near the product. Our representatives will be happy to assist you.

Location

For safe operation and satisfactory performance of your TV/VCR, remember the following:

- Shield it from direct sunlight and keep it away from sources of intense heat.
- Avoid dusty or humid places.
- Avoid places with insufficient ventilation. Do not block the ventilation openings at the top and bottom of the TV/VCR. Do not place the TV/VCR on a carpet, as this will block the ventilation openings.
- Avoid locations subject to strong vibrations.
- Do not place the TV/VCR near strong magnetic fields.
- Do not move the TV/VCR from a cold place to a hot place, or vice versa.
- Do not use this TV/VCR under high temperature conditions (maximum operating temperature: 104°F).

Electrical Shock and Fire Hazards

- Do not handle the power cord with wet hands.
- Do not pull the power cord when disconnecting the TV/VCR from the AC (alternating current) wall outlet. Grasp it by the plug.
- If you spill water on the TV/VCR, unplug the power cord immediately and take the TV/VCR to an authorized service center.
- Do not put your fingers or objects into the TV/VCR cassette compartment.
- Do not place anything on top of the TV/VCR.

Dew Warning (Moisture Condensation)

- Moisture may condense inside the unit when you move it from a cold place to a warm place, after heating a cold room, or when the humidity is high. There is no warning that moisture is in your TV/VCR. Playing a tape in a TV/VCR in which moisture has accumulated could damage the tape and the TV/VCR. If you suspect moisture inside the TV/VCR, keep the TV/VCR power on (but do not play a tape) for at least two hours. This will allow the TV/VCR to dry.

TV/VCR will not perform a timer recording.

- Set the recording start and stop times correctly. *Details are on pages 26-28.* Midnight is 12 a.m. Noon is 12 p.m.
- Make sure the TV/VCR power is off.
- Set the clock. *Details are on pages 12-15.*
- Put a tape in the TV/VCR. The tape must have a record tab.
- With ShowGuard, you don't have to worry about losing your timer recordings. If the power fails, timer recordings will be restored when the clock is reset. (The clock will reset itself automatically if you are using AUTO CLOCK. *Details are on pages 12-13.* If you are not using AUTO CLOCK, reset the clock manually. *Details are on pages 14-15.*) The timer recording will not occur only if it was scheduled to take place during the power failure.

TV/VCR will not record.

- Make sure the tape has a record tab. *Details are on page five.*
- Plug the power cord into an active AC outlet. *Details are on page six.* Or, plug the car battery cord into your vehicle's cigarette lighter. *Details are on page seven.*
- Check your hookups. *Details are on pages six-seven.*
- Set up the channels. *Details are on pages eight and 10.*

Channel reception is poor.

- Check connections, then set up the channels again. *Details are on pages eight and 10.*

TV/VCR power shuts off after 15 minutes.

- To save energy, the TV/VCR will shut itself off after 15 minutes when it is on a channel that is not receiving a broadcast signal (for example, a station that has gone off the air for the night). This is normal.

Helpful Hints (cont'd) 39

The remote control is not available, or the remote control will not access the menu.

- Use the buttons on the front of the TV/VCR to access the menu. You cannot enter numbers (for example, to program a timer recording) using the front panel buttons. *Details are on page 18.*

TV/VCR has no power.

- Connect the power plug to an AC (alternating current) outlet completely. Or, plug the car battery cord into your vehicle's cigarette lighter.

TV/VCR does not have a picture.

- Adjust the antenna. *Details are on pages six-seven.*
- Adjust the TV/VCR picture controls. *Details are on page 21.*
- Select an active channel.

TV/VCR has poor sound or no sound.

- Adjust the volume or press the MUTE button to restore the volume.

Tape playback is poor or tape is destroyed.

- Adjust the tracking. *Details are on page 37.*
- Use the Rental feature. *Details are on page 32.*
- If moisture has accumulated in your TV/VCR, keep the power on for at least two hours, but do not try to play a tape. *Details are on page 38.*

Remote control does not operate TV/VCR.

- Aim the remote control directly at the TV/VCR's remote sensor. *Details are on pages five and 18.*
- Remove all obstacles between the remote control and the TV/VCR.
- Inspect and replace the batteries in the remote control. *Details are on page five.*

Number buttons will not select channels above 69.

- Enter channel numbers as a two-digit number. If you want to select channels 100 and above, press the +100 button, then the Number buttons for the last two digits. *Details are on page eight.*
- If you are using an antenna and do not have Cable TV service, only channels 2-69 will be available. *Details are on pages eight and 10-11.*

You cannot insert a tape into the TV/VCR.

- Insert the tape window side up, with the record tab facing you.
- Make sure a tape isn't already in the TV/VCR by pressing the STOP/EJECT button on the TV/VCR.
- Gently push on the center of the tape. Never force a tape into the TV/VCR.
- If you have set a timer recording and the TV/VCR power is off, the TV/VCR will eject the tape if the record tab is missing.

You cannot remove the tape from the TV/VCR.

- Make sure the power plug is completely connected to an AC (alternating current) outlet. Or, make sure the car battery cord is completely connected to your vehicle's cigarette lighter.
- If a timer recording is programmed, turn on the TV/VCR power, then eject the tape. Be sure to insert a tape and turn off the TV/VCR power for the timer recording.
- Unplug the TV/VCR power cord for five minutes. Then, plug in the power cord again, then press the POWER button on the TV/VCR. If the tape does not eject, press the STOP/EJECT button on the TV/VCR three to five times. If the tape still does not eject, you may need an authorized servicer to remove the tape.

TV/VCR ejects the tape when you try to start a recording.

- Make sure the tape has a record tab. *Details are on page five.*

The cylinder rotates when tape playback is stopped.

- To enable the quick play mechanism, the cylinder will rotate for about five minutes. This is normal. The quick play mechanism switches the tape mechanism from Stop to Play in just one second.

Automatic clock setting won't work.

- Disconnect the car battery cord from the DC 13.2V jack. Instead, connect the AC power cord to the AC 120V jack on the TV/VCR and to an AC power outlet to supply standard electrical power. *Details are on pages six-seven.*
- Make sure channels are set and you have connected an antenna or Cable TV signal. *Details are on pages eight and 10.*

40 Glossary

AUDIO In Jack: jack on the front of the TV/VCR which is used to record audio from another source.

Automatic Channel Setup: process in which the TV/VCR memorizes all available channels. Then, when you push the CH(annel) ▲/▼ button, you only scan through channels you receive.

Auxiliary (AUX): The channel to which you set your TV/VCR during dubbing or when viewing material that is playing on another device that is connected to the TV/VCR (for example, a camcorder or VCR). The auxiliary (or line input) channel is always channel 00 (AUX).

Bands: settings that allow you to tune channels.

- **Antenna** – VHF (very high frequency; channels 2-13) and UHF (ultra high frequency; channels 14-69).
- **Cable** – all standard channels can be received without a Cable Box.

Brightness: adjusting increases or decreases the brightness of the color on the screen.

Color: adjusting pales or brightens the TV/VCR color.

Dubbing: copying a tape using a VCR.

HQ: high quality; a feature in the TV/VCR circuitry which provides enhanced picture detail.

Mode: a TV/VCR operation.

OTR: One-Touch Recording; a timed recording that starts immediately and records for 30 minutes to eight hours, whichever you specify.

Picture: adjusting increases or decreases the contrast of the picture on the screen.

Sharpness: adjusting softens or clarifies the picture on the screen.

Tape Speeds: how fast the tape travels during playback or recording.

- **SP** (standard play) – fastest tape speed (recording time for a T120 tape is approximately two hours); best picture quality.
- **LP** (long play) – average tape speed; playback only.
- **SLP** (super long play) – slowest tape speed (recording time for a T120 tape is approximately six hours).

Tint: adjusting changes the tints of the picture on the TV/VCR from purple to green.

VIDEO In Jack: jack on the front of the TV/VCR which is used to record video from another source.

Specifications 41

General

CRT: 9-inch in line gun
Television system: NTSC
Video Heads: Two heads
Tape width: 1/2 inch (12.65 mm)
Tape speed
 SP: 33.35 mm/sec.
 LP: 16.67 mm/sec.
 SLP: 11.12 mm/sec.
Operating Temperature: 41°F (5°C) to 104°F (40°C)
Relative Humidity: 10% to 75%
Power requirement: AC 120V, 60 Hz/DC 13.2V
Power consumption: 55W (AC), 60W (DC)
Sound output: 0.8W
Dimensions:
 13" (H) x 12-1/8" (W) x 12-15/16" (D)
 330mm x 308mm x 329mm
Weight: 18.5 lbs (8.4 kg)

Tuner Broadcast Channels

VHF 2-13, UHF 14-69

Cable TV Channels

1-125

Terminals

Antenna In: VHF/UHF 75 ohms unbalanced
Video In: RCA connector
Audio In: RCA connector
Earphone: 3.5 mm CES

Electrical Specifications

Video input level: 0.5~2.0Vp-p
Audio input level: -10dBv
Video S/N ratio
 SP: More than 42dB_p
Audio S/N ratio
 SP: More than 38dB

Designs and specifications are subject to change without notice and without our legal obligation.

42 Limited Warranty

TV/VCR COMBINATION

90 Days Free Labor/One Year Free Parts Exchange (Two Years Free Exchange on Color Picture Tube)

This product must be carried in for repair.

WHO IS COVERED?

You must have proof of purchase to receive warranty service. A sales receipt or other document showing that you purchased the product is considered proof of purchase.

WHAT IS COVERED?

Warranty coverage begins the day you buy your product. *For 90 days thereafter*, all parts will be repaired or replaced, and labor is free. *From 90 days to one year from the day of purchase*, all parts will be repaired or replaced, but you pay for all labor charges. *From one to two years from the day of purchase*, you pay for the replacement or repair of all parts except the picture tube, and for all labor charges. *After two years from the day of purchase*, you pay for the replacement or repair of all parts, and for all labor charges.

All parts, including repaired and replaced parts, are covered only for the original warranty period. When the warranty on the product expires, the warranty on all replaced and repaired parts also expires.

WHAT IS EXCLUDED?

Your warranty does not cover:

- labor charges for installation or setup of the product, adjustment of customer controls on the product, and installation or repair of antenna systems outside of the product.
- product repair and/or part replacement because of misuse, accident, unauthorized repair or other cause not within the control of Magnavox.
- reception problems caused by signal conditions or cable or antenna systems outside the unit.
- a product that requires modification or adaptation to enable it to operate in any country other than the country for which it was designed, manufactured, approved and/or authorized, or repair of products damaged by these modifications.
- incidental or consequential damages resulting from the product. (Some states do not allow the exclusion of incidental or consequential damages, so the above exclusion may not apply to you. This includes, but is not limited to, prerecorded material, whether copyrighted or not copyrighted.)
- damage caused by the use of non-VHS tapes or tapes that have not been tested and labeled for use in two, four, six, and eight hour VHS recorders.
- a product that is used for commercial or institutional purposes.

WHERE IS SERVICE AVAILABLE?

Warranty service is available in all countries where the product is officially distributed by Magnavox. In

countries where Magnavox does not distribute the product, the local Magnavox service organization will attempt to provide service (although there may be a delay if the appropriate spare parts and technical manual(s) are not readily available).

MAKE SURE YOU KEEP...

Please keep your sales receipt or other document showing proof of purchase. Attach it to this owner's manual and keep both nearby. Also keep the original box and packing material in case you need to return your product.

BEFORE REQUESTING SERVICE...

Please check your owner's manual before requesting service. Adjustments of the controls discussed there may save you a service call.

TO GET WARRANTY SERVICE IN U.S.A., PUERTO RICO OR U.S. VIRGIN ISLANDS...

Take the product to a Magnavox factory service center (see enclosed list) or authorized service center for repair. When the product has been repaired, you must pick up the unit at the center. Centers may keep defective parts.

(In U.S.A., Puerto Rico and U.S. Virgin Islands, all implied warranties, including implied warranties of merchantability and fitness for a particular purpose, are limited in duration to the duration of this express warranty. But, because some states do not allow limitations on how long an implied warranty may last, this limitation may not apply to you.)

TO GET WARRANTY SERVICE IN CANADA...

Please contact Magnavox at:

1-800-705-2000.

(In Canada, this warranty is given in lieu of all other warranties. No other warranties are expressed or implied, including any implied warranties of merchantability or fitness for a particular purpose. Magnavox is not liable under any circumstances for any direct, indirect, special, incidental or consequential damages, howsoever incurred, even if notified of the possibility of such damages.)

REMEMBER...

Please record below the model and serial numbers found on the product. Also, please fill out and mail your warranty registration card promptly. It will be easier for us to notify you if necessary.

MODEL # _____
SERIAL # _____

This warranty gives you specific legal rights. You may have other rights which vary from state to state.

Magnavox, P.O. Box 520890, Miami, FL 33152 (402) 536-4171

Index 43

-
- accessories 44
 - alt.ch button 17
 - ant(enna) jack 6, 19
 - audio in jack 18, 30
 - auto return 29
 - automatic
 - playback 37
 - rewind 37
 - auxiliary mode (aux) 30, 40

 - batteries 5
 - brightness, adjusting 21

 - channel
 - above 100 8
 - adding 11
 - buttons 17, 18, 37
 - deleting 11
 - setup 8, 10
 - clock 12-15
 - color, adjusting 21
 - connections 6-7, 30
 - contents, table of 4
 - contrast, adjusting 21
 - controls
 - remote 17
 - tv/vcr 18

 - daylight-savings time 16
 - dc 13.2v jack 7, 19
 - display button 17, 20
 - duplication 30

 - earphone jack 18
 - ejecting a tape 39

 - fast forward search 23
 - f.fwd/▶ button 17, 23
 - f.fwd button 18
 - front panel 18

 - glossary 40

 - helpful hints 38-39
 - hookups 6-7, 30

 - language selection 9
 - line input mode 30, 40
 - long play 24, 40
 - lp 24, 40

 - menu
 - button 17
 - front panel button access 18
 - mute button 17
 - number buttons 17
 - one-touch recording 25
 - pause/still button 17, 23
 - picture, adjusting 21
 - play button 17, 18
 - playback options 23
 - playing 22
 - power
 - button 17, 18
 - cord 6, 7, 19
 - rear panel 19
 - rec/otr button 18, 25
 - rec(ord) light 18
 - recording 24
 - recording prevention 5
 - remote control
 - buttons 17
 - using 5
 - remote sensor 18
 - repeat play 31
 - rerecording 30
 - rew(ind) button 18
 - rew(ind)/◀ button 17, 23
 - rewinding 23

 - safety precautions 3
 - searching 23, 34
 - sensor (remote) 18
 - sharpness, adjusting 21
 - sleep timer 35
 - slp 24, 40
 - sp 24, 40
 - specifications 41
 - status display 20
 - still picture 23
 - stop/▼ button 17
 - stop/eject button 18
 - super high speed searching 23
 - super long play 24, 40
 - table of contents 4

 - tape
 - duplication 30
 - speed 24, 40
 - time
 - search 34
 - setting 12-15
 - timer recording
 - cancelling 28
 - setting 26-27
 - tint, adjusting 21
 - tracking 37

 - video in jack 18, 30

 - wake up timer 36
 - warranty 42

 - zero position 33
 - zero return 33

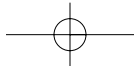

SUPPLIED ACCESSORIES

The following items are supplied with your TV/VCR; they are provided to help you use or set up your TV/VCR.

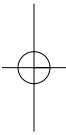
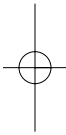
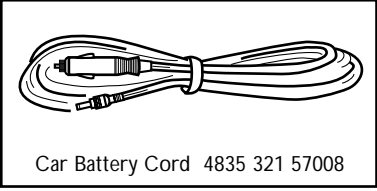
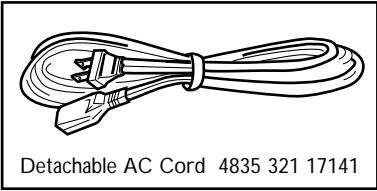
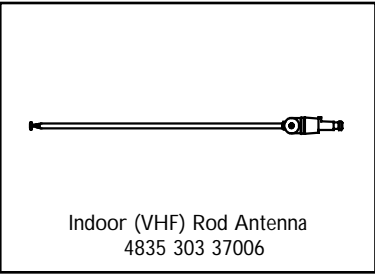
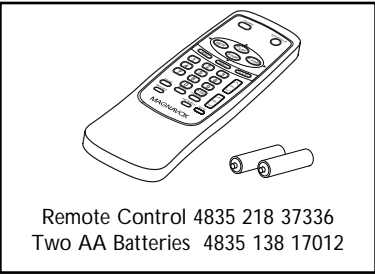

This owner's manual is made of recycled paper.



As an ENERGY STAR® Partner, Magnavox has determined that this product meets the ENERGY STAR® guidelines for energy efficiency.

ENERGY STAR® is a U.S. registered mark.

IB8365E001
Printed In Malaysia
0EMN02000 / T4319UV *****

